

# **Official Wheelchair Basketball Rules 2006**

As approved by

**IWBF Executive Council**

July, 2006

Amsterdam, The Netherlands

**Valid as at**

**October 2006**



**THIS RULE BOOK IS PUBLISHED BY**

**INTERNATIONAL WHEELCHAIR BASKETBALL FEDERATION (IWBF)**  
(Founded 1973)

© Copyright: IWBF  
Edited by: IWBF

Based on the Official Basketball Rules of FIBA

All rights reserved. No part of this publication may be reproduced, stored in a retrieval system, or transmitted in any form or by any means, electronic or mechanical, photocopying, recording or otherwise, without the prior written permission of the publisher.

**Postal Address & Office Location:**

189 Watson Street #109  
Winnipeg, MB, Canada  
R2P 2E1

Phone: 1-204-632-6475  
Fax: 1-204-697-2734  
E-Mail: [IWBFSecretariat@aol.com](mailto:IWBFSecretariat@aol.com)  
Website: <http://www.iwbf.org>

**President IWBF:** Mrs. Maureen Orchard, Canada

**TABLE OF CONTENTS**

<b>RULE ONE – THE GAME .....</b>	<b>7</b>
Art. 1 Definitions .....	7
<b>RULE TWO – COURT AND EQUIPMENT .....</b>	<b>8</b>
Art. 2 Court .....	8
Art. 3 Equipment.....	12
<b>RULE THREE - TEAMS .....</b>	<b>15</b>
Art. 4 Teams.....	15
Art. 5 Players: Injury .....	17
Art. 6 Captain: Duties and powers.....	17
Art. 7 Coaches: Duties and powers .....	18
<b>RULE FOUR - PLAYING REGULATIONS.....</b>	<b>19</b>
Art. 8 Playing time, tied score and extra periods .....	19
Art. 9 Beginning and end of a period or the game .....	19
Art. 10 Status of the ball .....	20
Art. 11 Location of a player and an official.....	21
Art. 12 Tap-off and alternating possession .....	21
Art. 13 How the ball is played .....	23
Art. 14 Control of the ball.....	23
Art. 15 Player in the act of shooting.....	24
Art. 16 Goal: When made and its value .....	24
Art. 17 Throw-in.....	25
Art. 18 Time-out.....	27
Art. 19 Substitution .....	28
Art. 20 Game lost by forfeit.....	30
Art. 21 Game lost by default .....	30
<b>RULE FIVE - VIOLATIONS .....</b>	<b>32</b>
Art. 22 Violations .....	32
Art. 23 Player out-of-bounds and ball out-of-bounds .....	32
Art. 24 Dribbling.....	32
Art. 25 Travelling (Three Pushes).....	33
Art. 26 Three seconds .....	33
Art. 27 Closely guarded player .....	34
Art. 28 Eight seconds .....	34
Art. 29 Twenty-four seconds.....	35
Art. 30 Ball returned to the backcourt .....	36
Art. 31 Lifting and Rear Wheels Off the Floor .....	36
<b>RULE SIX - FOULS.....</b>	<b>38</b>
Art. 32 Fouls .....	38
Art. 33 Contact: General principles.....	38
Art. 34 Personal foul.....	44
Art. 35 Double foul.....	44
Art. 36 Unsportsmanlike foul .....	45
Art. 37 Disqualifying foul.....	45
Art. 38 Technical foul.....	47
Art. 39 Fighting .....	49



<b>RULE SEVEN – GENERAL PROVISIONS .....</b>	<b>50</b>
Art. 40 Five fouls by a player .....	50
Art. 41 Team fouls: Penalty .....	50
Art. 42 Special situations .....	50
Art. 43 Free throws .....	51
Art. 44 Correctable errors .....	53
<b>RULE EIGHT – OFFICIALS, TABLE OFFICIALS, COMMISSIONER: DUTIES AND POWERS .....</b>	<b>56</b>
Art. 45 Officials, table officials and commissioner .....	56
Art. 46 Referee: Duties and powers .....	56
Art. 47 Officials: Duties and powers .....	57
Art. 48 Scorer and assistant scorer: Duties .....	58
Art. 49 Timer: Duties.....	59
Art. 50 Twenty-four second operator: Duties .....	60
<b>RULE NINE - PLAYER CLASSIFICATION SYSTEM .....</b>	<b>62</b>
Art. 51 Player Classification Point System.....	62
<b>A - OFFICIALS’ SIGNALS .....</b>	<b>63</b>
<b>B - THE SCORESHEET .....</b>	<b>69</b>
<b>C - PROTEST PROCEDURE .....</b>	<b>76</b>
<b>D - CLASSIFICATION OF TEAMS .....</b>	<b>77</b>
<b>E - TELEVISION (TV) TIME-OUTS .....</b>	<b>81</b>
<b>INDEX TO THE RULES .....</b>	<b>82</b>

**TABLE OF DIAGRAMS**

Diagram 1	Full size playing court .....	9
Diagram 2	Restricted area .....	11
Diagram 3	Two-point/Three-point field goal area .....	11
Diagram 4	Scorer's table and substitution space .....	12
Diagram 5	Wheelchair dimensions .....	14
Diagram 6	Cylinder Principle.....	39
Diagram 7	Players' positions during free throws .....	52
Diagram 8	Officials' signals.....	63
Diagram 9	Scoresheet .....	69
Diagram 10	Top of the scoresheet.....	70
Diagram 11	Teams on the scoresheet .....	71
Diagram 12	Running score .....	74
Diagram 13	Summing up .....	75
Diagram 14	Bottom of the scoresheet.....	75



## IWBF Technical Commission

<b>President</b>	Norbert Kucera, Germany
<b>Secretary</b>	Don "Butch" Steponchev, Canada
<b>Members</b>	Ricardo Moreno, Spain Walter Pfaller, Austria Nico Viviers, South Africa Kaneyoshi Sugiyama, Japan
<b>Ex-officio Member</b>	Mrs. Maureen Orchard, Canada



These rules for wheelchair basketball as played under the jurisdiction of the International Wheelchair Basketball Federation (IWBF) have been compiled as a result of years of experience in the field of wheelchair basketball. They are based on rules laid down by the International Basketball Federation (FIBA)

**Throughout the Official Wheelchair Basketball Rules, all references made to a player, coach, official, etc. in the male gender also apply to the female gender. It must be understood that this is done for practical reasons only.**

---

## **RULE ONE – THE GAME**

---

### **Art. 1 Definitions**

#### **1.1 Wheelchair basketball game**

Wheelchair basketball is played by two (2) teams of five (5) players each. The aim of each team is to score in the opponent's basket and to prevent the other team from scoring.

The game is controlled by officials, table officials, a commissioner and a classifier.

#### **1.2 Basket: opponent's/own**

The basket that is attacked by a team is the opponent's basket and the basket which is defended by a team is the team's own basket.

#### **1.3 Winner of a game**

The team that has scored the greater number of points at the end of playing time shall be the winner.



---

## **RULE TWO – COURT AND EQUIPMENT**

---

### **Art. 2 Court**

#### **2.1 Playing court**

The playing court shall have a flat, hard surface free from obstructions (Diagram 1) with dimensions of twenty-eight (28) m in length by fifteen (15) m in width measured from the inside edge of the boundary line.

The national federations have the authority to approve, for their competitions, existing playing courts with minimum dimensions of twenty-six (26) m in length by fourteen (14) m in width.

#### **2.2 Lines**

All lines shall be drawn in the same colour (preferably white), five (5) cm in width and clearly visible.

##### **2.2.1 Boundary line**

The playing court shall be limited by the boundary line, consisting of the endlines (on the short sides) and the sidelines (on the long sides). These lines are not part of the playing court.

Any obstruction including seated team bench personnel shall be at least two (2) m from the playing court.

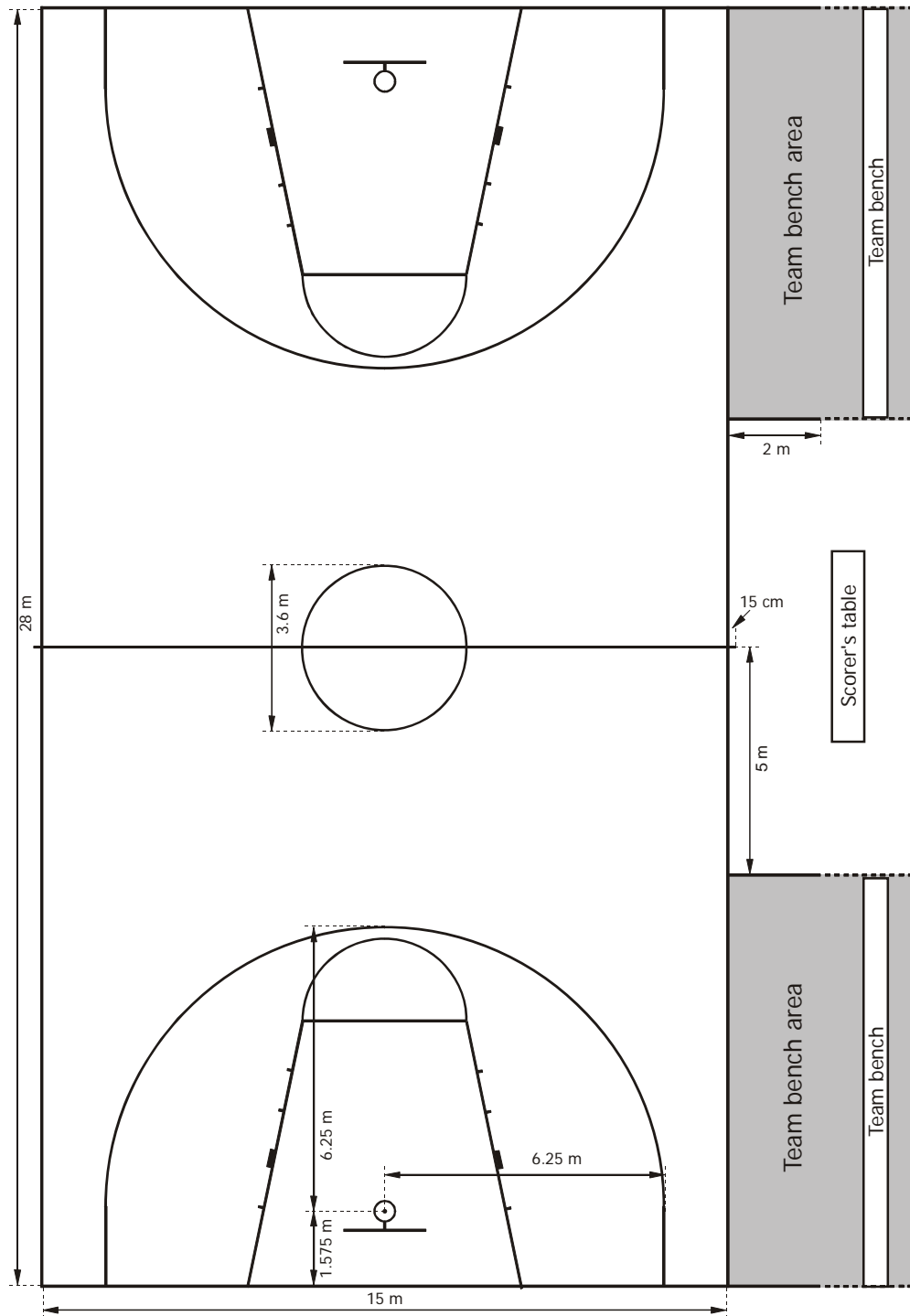

**Diagram 1 Full size playing court**



### 2.2.2 Centre line, centre circle and semicircles

The centre line shall be marked parallel to the endlines from the mid-points of the sidelines. It shall extend fifteen (15) cm beyond each sideline.

The centre circle shall be marked in the centre of the playing court and have a radius of 1.80 m measured to the outer edge of the circumference. If the inside of the centre circle is painted, it must be the same colour as the restricted areas.

The semicircles shall be marked on the playing court with a radius of 1.80 m measured to the outer edge of the circumference and with their centres at the mid-points of the free-throw lines (Diagram 2).

### 2.2.3 Free-throw lines and restricted areas

A free-throw line shall be drawn parallel to each endline. It shall have its furthest edge 5.80 m from the inner edge of the endline and shall be 3.60 m long. Its mid-point shall lie on the imaginary line joining the mid-points of the two endlines.

The restricted areas shall be the floor areas marked on the playing court, limited by the endlines, the free-throw lines and the lines which originate at the endlines, their outer edges being three (3) m from the mid-points of the endlines and terminating at the outer edge of the free-throw lines. These lines, excluding the endlines, are part of the restricted area. The inside of the restricted areas may be painted but must be the same colour as the centre circle.

Rebound places along the restricted areas, reserved for players during free throws, shall be marked as in Diagram 2.

### 2.2.4 Three-point field goal area

A team's three-point field goal area (Diagram 1 and Diagram 3) shall be the entire floor area of the playing court, except for the area near the opponent's basket, limited by and including:

- Two parallel lines extending from and perpendicular to the endline, with the furthest edges 6.25 m from the point on the floor directly perpendicular to the exact centre of the opponent's basket. The distance of this point from the inside edge of the mid-point of the endline is 1.575 m.
- A semicircle with the radius of 6.25 m measured to the outer edge of the circumference from the centre (which is the same point as defined above) which meets the parallel lines.

### 2.2.5 Team bench areas

Team bench areas (Diagram 1) shall be marked outside the playing court, on the same side as the scorer's table and the team benches.

Each area shall be limited by a line extending from the endline, at least two (2) m in length and by another line at least two (2) m in length, drawn five (5) m from the centre line and at right angles to the sideline.

There must be seven (7) seats available in the team bench area for the coaches, the assistant coaches, the substitutes and the team followers. All

players will use their wheelchairs at the bench. All other people shall be at least two (2) m behind the team bench.

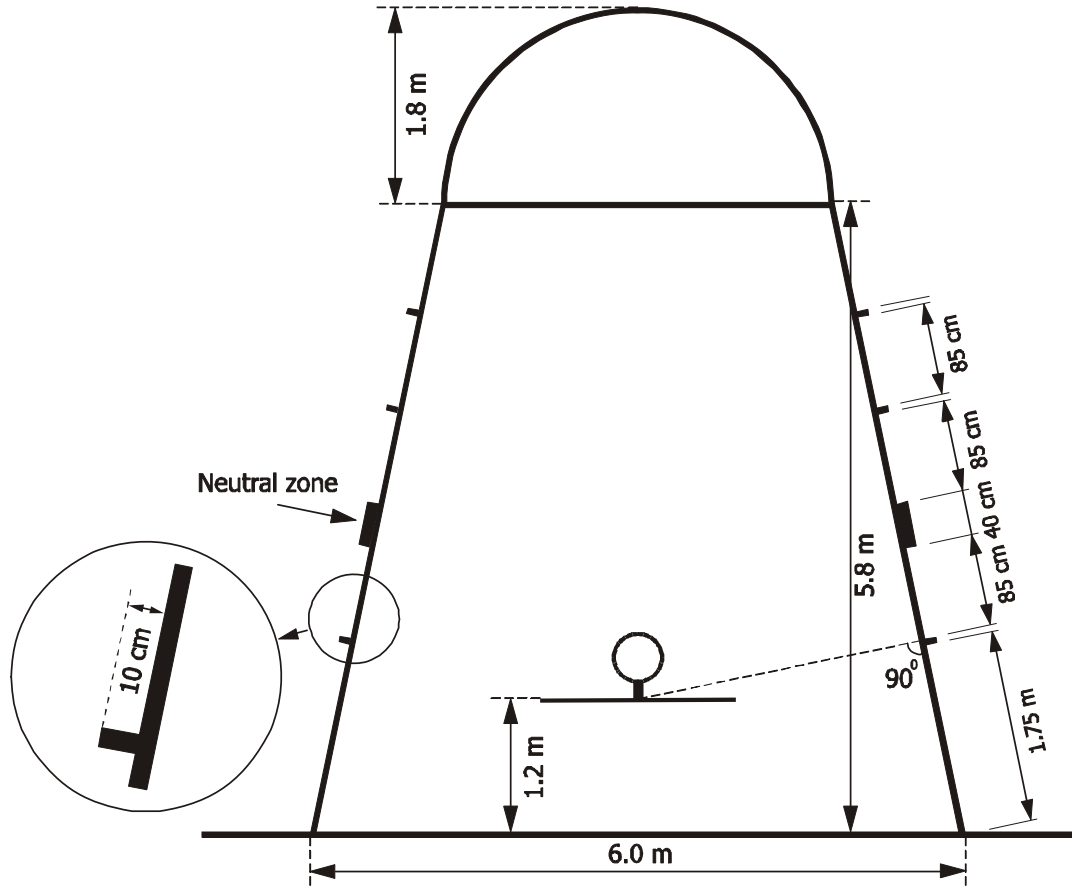

**Diagram 2 Restricted area**

The three-point line is not part of the three-point field goal area

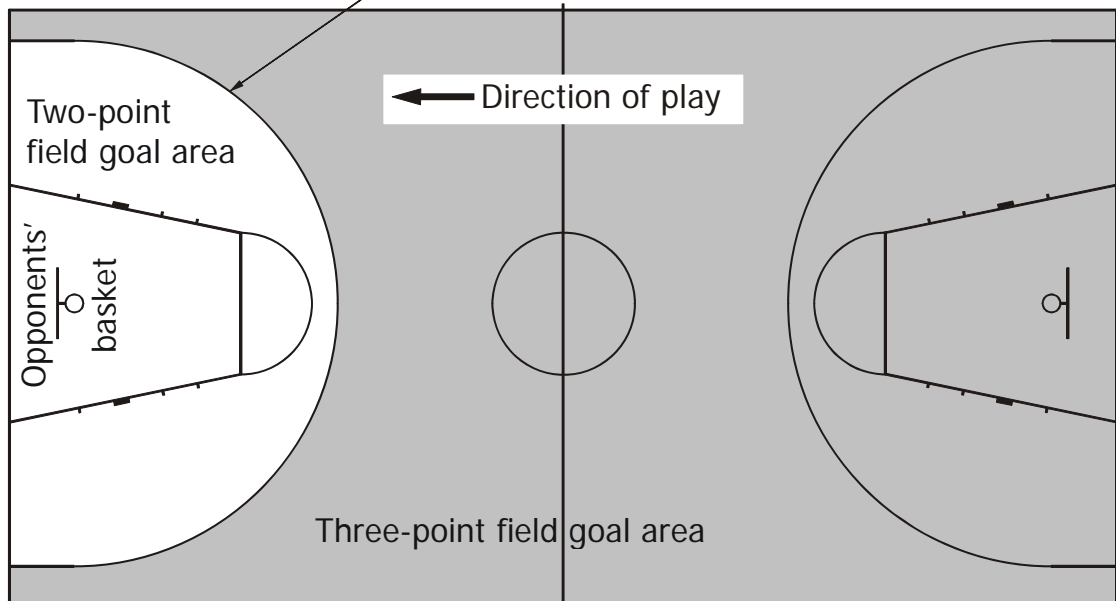

**Diagram 3 Two-point/Three-point field goal area**

### 2.3 Position of the scorer's table and substitution space (Diagram 4)

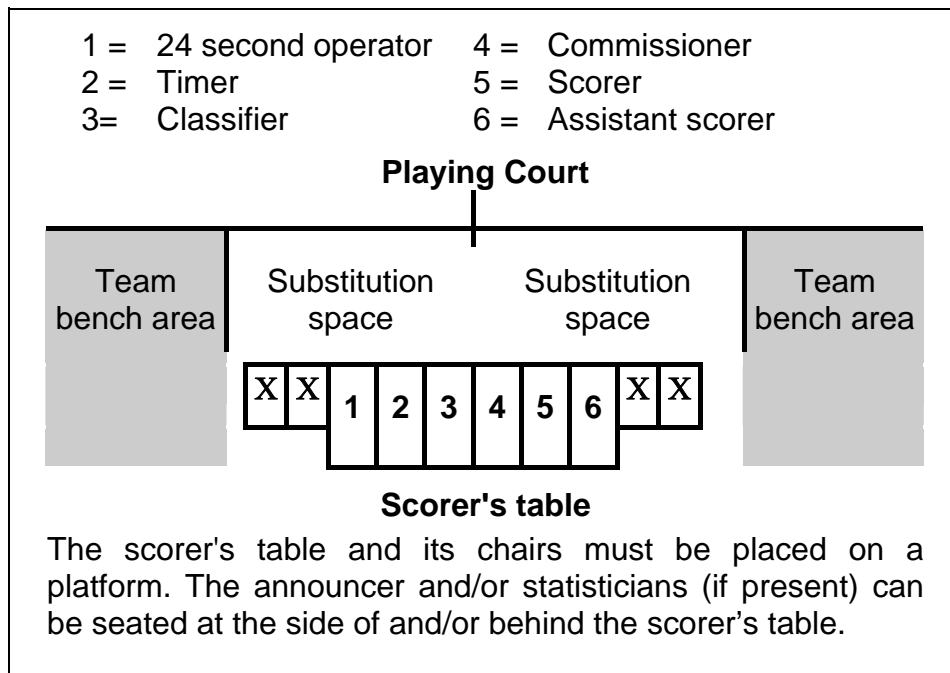

**Diagram 4 Scorer's table and substitution space**

### Art. 3 Equipment

The following equipment will be required:

- Backstop units, consisting of:
  - Backboards
  - Baskets comprising (pressure release) rings and nets
  - Backboard support structures including padding
- Basketballs
- Game clock
- Scoreboard
- Twenty-four second device
- Stopwatch or suitable (visible) device (not the game clock) for timing time-outs
- Two (2) separate, distinctly different and loud sound signals
- Scoresheet
- Player foul markers
- Team foul markers
- Alternating possession indicator
- Playing floor
- Playing court
- Adequate lighting

For a more detailed description of basketball equipment, see Appendix on Basketball Equipment.

### 3.1 Wheelchairs

3.1.1 Particular attention must be paid to the wheelchair, as it is considered to be part of the player. Contravention of the following rules will result in the wheelchair being banned from the game.

3.1.2 Only one cushion is permitted on the seat of the wheelchair. It must be of the same dimensions as the seat of the wheelchair; for 1, 1.5, 2, 2.5 and 3 point players it must not exceed 10 cm in thickness; for 3.5, 4 and 4.5 point players it must not exceed 5 cm. The cushion must be of even thickness and not wedge-shaped. No board or rigid materials are allowed on the seat in addition to the cushion. (See also Art. 4.4.1)

NOTE: There is no longer a requirement for the cushion to be sufficiently flexible such that it can be bent corner to corner.

3.1.3 The footrest, or, where applicable, the protective horizontal bar at the front/sides of the wheelchair, must be no higher than 11 cm from the floor at its most forward point and throughout its whole length. Such a bar may be straight or slightly curved but must not be pointed. This measurement is taken when the front castor(s) is in the forward driving position.

3.1.4 The underside of the footrests must be designed to prevent damage to the playing surface. A roller bar fitted to the underside of the foot rests for floor protection and a small anti-tip castor(s) attached to the back of the wheelchair for safety purposes is permitted.

3.1.5 Comment:

3.1.6 One or two anti-tip devices utilizing no more than a total of two small castors attached to **either the frame or the rear axle** and located at the rear of the wheelchair, castors that frequently or even continuously come into contact with the floor, can be added to the wheelchair. The width between castors must be limited to the distance between the inside of the two big wheels. When the player is sitting in the wheelchair and it is in the forward driving position, the maximum permissible distance between the bottom of the castor(s) and the playing surface is 2 cm. The anti-tip castor(s) must not protrude beyond the vertical plane that touches the rearmost points of the driving wheels. This alignment should be judged with the wheelchair in its forward driving position.

**Note:** Within the scope of this paragraph, an anti-tip castor(s) is not a wheel.

3.1.7 The maximum height to the top of the side seat rails from the floor, including the material that forms the seat of the wheelchair, must not exceed 53 cm when the front castor(s) is in the forward driving position.

3.1.8 The wheelchair shall have either three or four wheels – i.e. two large wheels at the back and one or two small wheels at the front of the chair. The large wheels, including the tyres, may have a maximum diameter of 69 cm. In the case of the three-wheel wheelchair, the small wheel (or castor) must be located at the centre and inside of the horizontal bar at the front of the wheelchair. A second small wheel (or castor) may be added to the single small wheel at the front of the wheelchair.

- 3.1.9 There must be one handrim on each wheel.
- 3.1.10 No steering devices, brakes or gears are allowed on the wheelchair.
- 3.1.11 Any tyre or castor(s) that marks the floor is not permitted. **Exceptions may be made where it can be demonstrated that the marks can be easily removed.**
- 3.1.12 Arm rests and other upper body supports that are attached to the wheelchair should not project beyond the line of the player's legs or trunk in the natural sitting position.
- 3.1.13 The padding of the horizontal bar located at the back of the backrest of the wheelchair must be of a minimum thickness of 1.5 cm (15mm). It must be sufficiently flexible to allow a maximum indentation of a third of its original thickness and may have a minimum indentation factor of fifty percent (50%). This means that when a force is applied suddenly to the padding, the indentation on the padding cannot exceed 50% of its original thickness. The padding is required to prevent injury to the other players.

Note 1: During a game it is possible to have a problem with the wheelchair that causes the wheelchair to no longer be functional or become unsafe. The referee will stop the game at an appropriate time to allow the team to complete the repair.

Note 2: It is possible that a player will fall out of the wheelchair without a foul occurring. The referee should pay careful attention to the need to protect the player when determining the appropriate time to stop the play.

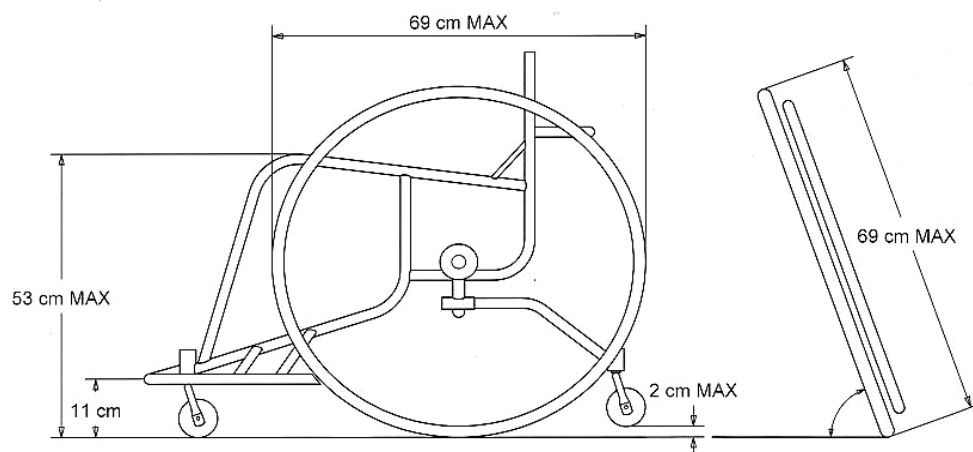

**Diagram 5 Wheelchair Dimensions**

---

## RULE THREE - TEAMS

---

### Art. 4 Teams

#### 4.1 Definition

- 4.1.1 A team member is eligible to play when he has been authorised to play for a team according to the regulations, including regulations governing age limits, of the organising body of the competition.
- 4.1.2 A team member is entitled to play when his name has been entered on the scoresheet before the start of the game and as long as he has neither been disqualified nor committed five (5) fouls.
- 4.1.3 During playing time, a team member is:
- A player when he is on the playing court and is entitled to play.
  - A substitute when he is not on the playing court but he is entitled to play.
  - An excluded player when he has committed five (5) fouls and is no longer entitled to play.
- 4.1.4 During an interval of play, all team members entitled to play are considered as players.

#### 4.2 Rule

- 4.2.1 Each team shall consist of:
- No more than twelve (12) team members entitled to play, including a captain.
  - A coach and, if a team wishes, an assistant coach.
  - A maximum of five (5) team followers who may sit on the bench and have special responsibilities, e.g. manager, doctor, physiotherapist, statistician, interpreter etc.
- 4.2.2 Five (5) players from each team shall be on the playing court during playing time and may be substituted.
- 4.2.3 A substitute becomes a player and a player becomes a substitute when:
- The official beckons the substitute to enter the playing court.
  - During a time-out or an interval of play, a substitute requests the substitution to the scorer.

#### 4.3 Uniforms

- 4.3.1 The uniform of the team members shall consist of:
- Shirts of the same dominant colour front and back.  
All players must tuck their shirts into their playing shorts. 'All-in-ones' are permitted.



- T-shirts, regardless of style, may be worn under shirts. The T-shirt must be of the same dominant colour as the shirt.
- Playing suit trousers or shorts of the same dominant colour front and back, but not necessarily of the same colour as the shirts.
- Undergarments that extend below the shorts may be worn provided they are of the same dominant colour as the shorts.

4.3.2 Each team member shall wear a shirt numbered on the front and back with plain numbers, of a solid colour contrasting with the colour of the shirt.

The numbers shall be clearly visible and:

- Those on the back shall be at least twenty (20) cm high.
- Those on the front shall be at least ten (10) cm high.
- The numbers shall be at least two (2) cm wide.
- Teams shall use numbers from four (4) to fifteen (15). National federations have the authority to approve, for their competitions, any other numbers with a maximum of two (2) digits.
- Players on the same team shall not wear the same number.
- Any advertising or logo shall be at least five (5) cm away from the numbers.

4.3.3 Teams must have a minimum of two sets of shirts and:

- The first team named in the programme (home team) shall wear light-coloured shirts (preferably white).
- The second team named in the programme (visiting team) shall wear dark-coloured shirts.
- However, if the two teams involved agree, they may interchange the colours of the shirts.

4.3.4 Playing barefoot is not permitted.

#### 4.4 Other equipment

4.4.1 All equipment used by players must be appropriate for the game. Any equipment that is designed to increase a player's height or reach or in any other way give an unfair advantage is not permitted.

4.4.2 Players shall not wear equipment (objects) that may cause injury to other players.

- The following **are not** permitted:
  - Finger, hand, wrist, elbow or forearm guards, casts or braces made of leather, plastic, pliable (soft) plastic, metal or any other hard substance, even if covered with soft padding.
  - Objects that could cut or cause abrasions (fingernails must be closely cut).
  - Headgear, hair accessories and jewellery.
- The following **are** permitted:
  - Shoulder, upper arm, thigh or lower leg protective equipment if the material is sufficiently padded.
  - Knee braces if they are properly covered.
  - Protector for an injured nose, even if made of a hard material.
  - Spectacles, if they do not pose a danger to other players.

- Headbands, maximum five (5) cm in width, made of non-abrasive, unicolour (the same dominate colour of the shirt) cloth, pliable plastic or rubber.

4.4.3 Any other equipment not specifically mentioned in this article must be approved by the IWBF Technical Commission.

## **Art. 5 Players: Injury**

5.1 In the event of injury to a player(s), the officials may stop the game.

5.2 If the ball is live when an injury occurs, the official shall not blow his whistle until the team in control of the ball has shot for a field goal, lost control of the ball, withheld the ball from play or the ball has become dead. If it is necessary to protect an injured player, the officials may interrupt the game immediately.

5.3 If the injured player cannot continue to play immediately (within approximately 15 seconds) or, if he receives treatment, he must be substituted or the team must continue to play with fewer than five (5) players.

5.4 Coaches, assistant coaches, substitutes and team followers may enter the playing court, with the permission of an official, to attend to an injured player before he is substituted.

5.5 A doctor may enter the playing court, without permission of an official if, in the doctor's judgement, the injured player requires immediate medical treatment.

5.6 During the game, any player who is bleeding or has an open wound must be substituted. He may return to the playing court only after bleeding has stopped and the affected area or open wound has been completely and securely covered.

If the injured player or any player who is bleeding or has an open wound recovers during a time-out taken by either team before the scorer's signal for the substitution, that player may continue to play.

5.7 Players who have been designated by the coach to start the game may be substituted in the event of an injury. In this case, the opponents are also entitled to substitute the same number of players, if they so wish.

## **Art. 6 Captain: Duties and powers**

6.1 The captain is a player who represents his team on the playing court. He may communicate in a courteous manner with the officials during the game to obtain information, however, only when the ball is dead and the game clock is stopped.

6.2 The captain shall, immediately at the end of the game, inform the referee if his team is protesting against the result of the game and sign the scoresheet in the space marked 'Captain's signature in case of protest'.



## **Art. 7 Coaches: Duties and powers**

- 7.1** At least twenty (20) minutes before the game is scheduled to begin, each coach or his representative shall give the scorer a list with the names, corresponding numbers and classification points of the team members who are eligible to play in the game, as well as the name of the captain of the team, the coach and the assistant coach. All team members whose names are entered on the scoresheet are entitled to play, even if they arrive after the beginning of the game.
- 7.2** At least ten (10) minutes before the game, each coach shall confirm his agreement with the names, corresponding numbers and classification points of their team members and the names of the coaches by signing the scoresheet. At the same time, they shall indicate the five (5) players who are to start the game. The coach of team 'A' shall be the first to provide this information.
- 7.3** The coaches and assistant coaches (as well as the substitutes and team followers) are the only persons permitted to be and to remain within their team bench area, unless otherwise stated in these rules.
- 7.4** The coach and the assistant coach may go to the scorer's table during the game to obtain statistical information only when the ball is dead and the game clock is stopped.
- 7.5** Only the coach is permitted to remain standing during the game. He may address the players verbally during the game provided he remains within his team bench area.
- 7.6** If there is an assistant coach his name must be entered on the scoresheet before the beginning of the game (his signature is not necessary). He shall assume all duties and powers of the coach if, for any reason, the coach is unable to continue.
- 7.7** When the captain leaves the playing court the coach shall inform an official of the number of the player who will act as captain on the playing court.
- 7.8** The captain shall act as coach if there is no coach, or if the coach is unable to continue and there is no assistant coach entered on the scoresheet (or the latter is unable to continue). If the captain must leave the playing court, he may continue to act as coach however, if he must leave following a disqualifying foul, or if he is unable to act as coach because of injury, his substitute as captain may replace him as coach.
- 7.9** The coach shall designate the free-throw shooter of his team in all cases where the free-throw shooter is not determined by the rules.

---

## **RULE FOUR - PLAYING REGULATIONS**

---

### **Art. 8 Playing time, tied score and extra periods**

- 8.1** The game shall consist of four (4) periods of ten (10) minutes.
- 8.2** There shall be intervals of play of two (2) minutes between the first and second period (first half), between the third and fourth period (second half) and before each extra period.
- 8.3** There shall be a half-time interval of play of fifteen (15) minutes.
- 8.4** There shall be an interval of play of twenty (20) minutes before the game is scheduled to begin.
- 8.5** An interval of play begins:
- Twenty (20) minutes before the game is scheduled to begin.
  - When the game-clock signal sounds for the end of a period.
- 8.6** An interval of play ends:
- At the beginning of the first period when the ball is legally tapped by a player involved in the tap-off.
  - At the beginning of all other periods when the ball touches or is legally touched by a player on the playing court after the throw-in.
- 8.7** If the score is tied at the end of playing time for the fourth period, the game shall continue with as many extra periods of five (5) minutes as is necessary to break the tie.
- 8.8** If a foul is committed when or just before the game clock signal sounds for the end of playing time, any eventual free throw(s) shall be taken after the end of playing time.
- 8.9** If an extra period is required as a result of this free throw(s) then all fouls that are committed after the end of playing time shall be considered to have occurred during an interval of play and the free throw(s) shall be administered before the beginning of the extra period.

### **Art. 9 Beginning and end of a period or the game**

- 9.1** The first period begins when the ball is legally tapped by a player involved in the tap-off.
- 9.2** All other periods begin when the ball touches or is legally touched by a player on the playing court after the throw-in.
- 9.3** The game cannot begin if one of the teams is not on the playing court with five (5) players ready to play.



- 9.4** For all games, the first team named in the programme (home team) shall have the team bench and its team's own basket on the left side of the scorer's table, facing the playing court.  
However, if the two teams agree, they may interchange the team benches and/or baskets.
- 9.5** Before the first and third periods, teams are entitled to warm-up in the half of the playing court in which their opponent's basket is situated.
- 9.6** Teams shall exchange baskets for the second half.
- 9.7** In all extra periods the teams shall continue to play towards the same baskets as in the fourth period.
- 9.8** A period, extra period or game shall end when the game clock signal sounds for the end of playing time.

#### **Art. 10 Status of the ball**

- 10.1** The ball can be either live or dead.
- 10.2** The ball becomes **live** when:
- During the tap-off, the ball is legally tapped by a player involved in the tap-off.
  - During a free throw, the ball is at the disposal of the free-throw shooter.
  - During a throw-in, the ball is at the disposal of a player for the throw-in.
- 10.3** The ball becomes **dead** when:
- Any field goal or free throw is made.
  - An official blows his whistle while the ball is live.
  - It is apparent that the ball will not enter the basket on a free throw which is to be followed by:
    - Another free throw(s).
    - A further penalty (free throw(s) and/or throw-in).
  - The game clock signal sounds for the end of the period.
  - The twenty-four second device signal sounds while a team is in control of the ball.
  - The ball which is in flight on a shot for a field goal is touched by a player from either team after:
    - An official blows his whistle.
    - The game clock signal sounds for the end of the period.
    - The twenty-four second device signal sounds.
- 10.4** The ball does **not** become **dead** and the goal counts if made when:
- The ball is in flight on a shot for a field goal and:
    - An official blows his whistle.
    - The game clock signal sounds for the end of the period.
    - The twenty-four second device signal sounds.
  - The ball is in flight on a free throw when an official blows his whistle for any rule infraction other than by the free-throw shooter.
  - A player commits a foul on any opponent while **the ball is in the control of the opponent** in the act of shooting for field goal and who

finishes his shot with a continuous motion which started before the foul occurred.

This provision does not apply and the goal shall not count if, after an official blows his whistle an entirely new act of shooting is made. This provision does not apply and the goal shall not count, if **during the continuous motion:**

- The game clock signal sounds for the end of the period.
- The twenty-four second device signal sounds.
- An entirely new act of shooting is made.

#### **Art. 11 Location of a player and an official**

**11.1** The location of a **player** is determined by where his wheelchair is touching the floor.

**11.2** The location of an **official** is determined in the same manner as that of a player. When the ball touches an official, it is the same as touching the floor at the official's location.

#### **Art. 12 Tap-off and alternating possession**

##### **12.1 Definition**

**12.1.1** A **tap-off** occurs when an official tosses the ball in the centre circle between any two opponents at the beginning of the first period.

**12.1.2** A **held ball** occurs when one or more players of each opposing team have one or both hands firmly on the ball so that neither player can gain control without undue roughness.

##### **12.2 Procedure**

**12.2.1** Each player involved in the tap-off shall have his wheelchair inside the half of the centre circle nearest to his team's own basket with one wheel close to the centre line.

**12.2.2** Team-mates may not occupy adjacent positions around the circle if an opponent wishes to occupy one of those positions.

**12.2.3** The official shall then toss the ball upwards (vertically) between the two opponents, higher than either of them can reach.

**12.2.4** The ball must be tapped with the hand(s) of one or both of the players involved in the tap-off **after** it reaches its highest point.

**12.2.5** Neither player involved in the tap-off shall leave his position until the ball has been legally tapped.

**12.2.6** Neither player involved in the tap-off may catch the ball or tap it more than twice until it has touched one of the eight other players, the floor or an official.

**12.2.7** If the ball is not tapped by at least one of the players involved in the tap-off, the tap-off shall be retaken.



12.2.8 No part of the eight other players' bodies or wheelchairs may be on or over the circle line (cylinder) before the ball has been tapped.

**An infraction of Art. 12.2.1, 12.2.4, 12.2.5, 12.2.6, and 12.2.8 is a violation.**

### 12.3 Tap-off situations

A tap-off situation occurs when:

- A held ball is called.
- The ball goes out-of-bounds and the officials are in doubt or disagree about which of the opponents last touched the ball.
- A double free-throw violation occurs during an unsuccessful last or only free throw.
- A live ball lodges on the basket support (except between free throws).
- The ball becomes dead when neither team had control of the ball nor was entitled to the ball.
- After the cancellation of equal penalties against both teams, there are no other foul penalties remaining for administration and neither team had control of the ball nor was entitled to the ball before the first foul or violation.
- All periods other than the first period are to begin.

### 12.4 Alternating possession

12.4.1 Alternating possession is a method of causing the ball to become live with a throw-in rather than a tap-off.

12.4.2 In all tap-off situations teams will alternate possession of the ball for a throw-in at the place nearest to where the tap-off situation occurs.

12.4.3 The team that does not gain control of the live ball on the playing court after the tap-off which began the first period will start the alternating possession.

12.4.4 The team entitled to the next alternating possession at the end of any period shall start the next period with a throw-in at the centre line extended, opposite the scorer's table.

12.4.5 Alternating possession:

- **Begins** when the ball is at the disposal of a player for the throw-in.
- **Ends** when:
  - The ball touches or is legally touched by a player on the playing court.
  - The throw-in team commits a violation.
  - A live ball lodges on the basket support during a throw-in.

12.4.6 The team entitled to the alternating possession throw-in shall be indicated by the alternating possession arrow in the direction of the opponent's basket. The direction of the arrow is reversed immediately when the alternating possession throw-in ends.

12.4.7 A violation by a team during its alternating possession throw-in causes that team to lose the alternating possession throw-in. The alternating possession arrow will be reversed immediately, indicating that the opponents of the

violating team will be entitled to the alternating possession throw-in at the next tap-off situation. The game shall then be resumed by awarding the ball to the opponents of the violating team for a throw-in as normally following a violation (i.e. not an alternating possession throw-in).

12.4.8 A foul by either team:

- Before the beginning of a period other than the first period, or
- During the alternating possession throw-in,
- Does not cause the throw-in team to lose that alternating possession throw-in.
- Should such a foul occur during the initial throw-in to start a period, after the ball has been placed at the disposal of the thrower-in but before it has touched a player on the playing court, then it is considered to have happened during playing time and is penalised accordingly.

**Art. 13 How the ball is played**

**13.1 Definition**

During the game, the ball is played with the hand(s) only and may be passed, thrown, tapped, rolled or dribbled in any direction, subject to the restrictions of these rules.

**13.2 Rule**

13.2.1 To **deliberately** push the ball with the wheelchair, kick or block it with any part of the leg or strike it with the fist is a violation. However, to **accidentally** come into contact with or touch the ball with the wheelchair or with any part of the leg **is not** a violation.

13.2.2 An infraction of Art. 13.2 is a violation.

**Art. 14 Control of the ball**

**14.1** Team control **starts** when a player of that team is in control of a live ball because he is holding or dribbling it or has a live ball at his disposal.

**14.2** Team control **continues** when:

- A player of that team is in control of a live ball.
- The ball is being passed between team-mates.

**14.3** Team control **ends** when:

- An opponent gains control.
- The ball becomes dead.
- The ball has left the player's hand(s) on a shot for a field goal or for a free throw

**14.4** It is a violation for a player in control of the ball or attempting to gain control of the ball to:

14.4.1 Touch the floor with any part of his body except the hand(s), or

14.4.2 Lean either forward or backward in the chair, causing it to tip so that any part of it, other than the tyre(s)/castor(s), touches the floor.



## Art. 15 Player in the act of shooting

**15.1** A **shot** for a field goal or a free throw is when the ball is held in a player's hand(s) and is then thrown through the air towards the opponent's basket.

A **tap** is when the ball is directed with the hand(s) towards the opponent's basket.

**Cock:** to position the shooting hand(s) so that the palm is almost fully or partially turned upwards when preparing to throw or release the ball towards the opponent's basket.

A tap is also considered as a shot for a field goal.

### 15.2 The act of shooting:

- **Begins** when the player starts the continuous movement normally preceding the release of the ball and, in the judgement of the official, he has started an attempt to score by cocking, then throwing, or tapping the ball towards the opponent's basket. It is not essential that the ball leaves the player's hand(s).
- The arm might be held so that the player cannot throw, yet he may be making an attempt.
- **Ends** when the ball has left the player's hand(s) and the follow-through of the shot is completed (i.e. the shooter's hand(s) completes its movement in the direction of the floor, the wheelchair or, in the case of an underhand shot, the basket).
- The player attempting to score might have his arm(s) held by an opponent, thus preventing him from scoring, even though he is considered to have made an attempt to score. In this case it is not essential that the ball leaves the player's hand(s).

There is no relationship between the number of legal pushes taken and the act of shooting.

### 15.3 A continuous movement in the act of shooting:

- Begins when the ball has come to rest in the player's hand(s) and the shooting motion, usually upward, has started.
- May include the player's arm(s) and/or body and/or wheelchair movement in his attempt to shoot for a field goal.
- Ends when an entirely new act of shooting is made.

## Art. 16 Goal: When made and its value

### 16.1 Definition

16.1.1 A goal is made when a live ball enters the basket from above and remains within or passes through the basket.

16.1.2 The ball is considered to be within the basket when the slightest part of the ball is within and below the level of the ring.

### 16.2 Rule

16.2.1 A goal is credited to the team attacking the opponents' basket into which the ball has entered as follows:

- A goal from a free throw counts one (1) point.
- A goal from the two-point field goal area counts two (2) points.
- A goal from the three-point field goal area counts three (3) points.

**Comment:** The two large wheels must be within the 3-point field goal area, i.e. the small wheels and castor(s) may be on or in front of the line of the 3-point field goal area.

- 16.2.2 If a player **accidentally** scores a field goal in his team's **own basket**, the goal counts two (2) points and shall be recorded as having been scored by the captain of the opposing team on the playing court.
- 16.2.3 If a player **deliberately** scores a field goal in his team's **own basket**, it is a violation and the goal does not count.
- 16.2.4 If a player causes the entire ball to pass through the basket from below, it is a violation.

## Art. 17 Throw-in

### 17.1 Definition

- 17.1.1 A throw-in occurs when the ball is passed into the playing court by the out-of-bounds player.

### 17.2 Procedure

- 17.2.1 An official must hand or place the ball at the disposal of the player taking the throw-in. He may also toss or bounce pass the ball provided that:
- 17.2.2 The official is no more than four (4) metres from the player who is to take the throw-in.
- 17.2.3 The player who is to take the throw-in is at the correct place as designated by the official.
- 17.2.4 The player shall take the throw-in at the place nearest to the infraction, as designated by the official, or where the game was stopped, **except directly** behind the backboard.
- 17.2.5 Only in the following situations shall the subsequent throw-in be taken at the centre line extended, opposite the scorer's table:
- At the beginning of all periods other than the first period
  - Following a free throw(s) resulting from a technical, unsportsmanlike or disqualifying foul
  - During the last two (2) minutes of the fourth (4<sup>th</sup>) period and during last two (2) minutes of each extra period, following a time-out granted to the team that has been entitled to the possession of the ball from its backcourt.

The player shall have one rear wheel on either side of the centre line extended and shall be entitled to pass the ball to a team-mate at any place on the playing court.



- 17.2.6 Following a personal foul committed by a player of the team in control of the live ball, or of the team entitled to the ball, the subsequent throw-in shall be taken at the place nearest to the infraction.
- 17.2.7 Whenever the ball enters the basket but the field goal or the free throw is not valid, the subsequent throw-in shall be taken at the free-throw line extended.
- 17.2.8 Following a successful field goal or a successful last or only free throw:
- Any player of the non-scoring team shall take the throw-in at any place at the endline where the goal was scored.
  - This is also applicable after an official hands or places the ball at the disposal of the player taking the throw-in after a time-out or after any interruption of the game following a successful field goal or successful last or only free throw.
  - The player taking the throw-in may move laterally and/or backwards and the ball may be passed between team-mates on or behind the endline, but the five (5) second count starts when the ball is at the disposal of the first player out-of-bounds.

### 17.3 Rule

- 17.3.1 A player taking a throw-in shall **not**:
- Take more than five (5) seconds to release the ball.
  - Move in to the playing court while having the ball in his hand(s).
  - Cause the ball to touch out-of-bounds, after it has been released on the throw-in.
  - Touch the ball on the playing court before it has touched another player.
  - Cause the ball to enter the basket directly.
  - Move a total distance from the designated throw-in place, laterally in one or in both directions, not to exceed a total of one (1) metre before or while releasing the ball. He is, however, permitted to move directly backwards from the line as far as circumstances allow.
- 17.3.2 Other player(s) shall **not**:
- Have any part of their bodies or wheelchairs over the boundary line before the ball has been thrown across the boundary line.
  - Be closer than one (1) metre to the player taking the throw-in when the out-of-bounds area, free from obstruction at the throw-in place, is less than two (2) metres to the boundary line.
- 17.3.3 An offensive player is not allowed to enter the restricted area during an out-of bounds situation until the ball is at the disposal of a player for the throw-in. (see Rule 26.1.1)

**An infraction of Art. 17.3 is a violation.**

### 17.4 Penalty

The ball is awarded to the opponents for a throw-in at the place of the original throw-in.

## Art. 18 Time-out

### 18.1 Definition

A time-out is an interruption of the game requested by the coach or assistant coach.

### 18.2 Rule

18.2.1 Each time-out shall last one (1) minute.

18.2.2 A time-out may be granted during a time-out opportunity.

18.2.3 A time-out opportunity begins when:

- The ball becomes dead, the game clock is stopped and the official has ended his communication with the scorer's table.
- The ball becomes dead following a last or only successful free throw.
- For the non-scoring team, a field goal is scored.

18.2.4 A time-out opportunity **ends** when the ball is at the disposal of a player for a throw-in or a first or only free throw.

18.2.5 Two (2) time-outs may be granted to each team at any time during the first half; three (3) at any time during the second half and one (1) during each extra period.

18.2.6 Unused time-outs may not be carried over to the next half or extra period.

18.2.7 A time-out is charged against the team whose coach first made a request unless the time-out is granted following a field goal scored by the opponents and without a foul or a violation having been called.

### 18.3 Procedure

18.3.1 Only a coach or assistant coach has the right to request a time-out. He shall establish visual contact with the scorer or he shall go to the scorer's table and ask clearly for a time-out, making the proper conventional sign with his hands.

18.3.2 A time-out request may be cancelled only before the scorer's signal has sounded for such a request.

18.3.3 The time-out:

- **Begins** when an official blows his whistle and gives the time-out signal.
- **Ends** when the official blows his whistle and beckons the teams back on the playing court.

18.3.4 As soon as a time-out opportunity begins, the scorer shall sound his signal to notify the officials that a request for a time-out has been made.

If a field goal is scored against a team which has requested a time-out, the timer shall immediately stop the game clock and sound his signal.

18.3.5 During the time-out and during an interval of play before the beginning of the second (2<sup>nd</sup>), fourth (4<sup>th</sup>) or each extra period the players may leave the playing court and sit on the team bench and the persons permitted to be in



the team bench area may enter the playing court provided that the team members remain within the vicinity of their team bench area.

18.3.6 If the request for the time-out is made after the ball is at the disposal of the free-throw shooter for the first or only free throw, the time-out shall be granted for either team if:

- The last or only free throw is successful.
- It is followed by a throw-in from the centre line extended.
- A foul is called between free throws. In this case the free throw(s) will be completed and the time-out will be permitted before the new foul penalty is administered.
- A foul is called before the ball becomes live after the last or only free throw. In this case the time-out will be permitted before the new foul penalty is administered.
- A violation is called before the ball becomes live after the last or only free throw. In this case the time out will be permitted before the throw-in is administered.

In the event of consecutive sets of free throws and/or possession of the ball resulting from more than one (1) foul penalty call, each set is to be treated separately.

18.3.7 A time-out shall not be permitted to the scoring team when the game clock is stopped following a successful field goal during the last two (2) minutes of the fourth (4<sup>th</sup>) period or the last two (2) minutes of each extra period unless:

- An official has interrupted the game.
- The non-scoring team has been granted a time-out or substitution.

## **Art. 19 Substitution**

### **19.1 Definition**

A substitution is an interruption of the game requested by the substitute to become a player.

### **19.2 Rule**

19.2.1 A team may substitute a player(s) during a substitution opportunity.

19.2.2 A substitution opportunity **begins** when:

- The ball becomes dead, the game clock is stopped and the official has ended his communication with the scorer's table.
- The ball becomes dead following a last or only successful free throw.
- For the non-scoring team, a field goal is scored in the last two (2) minutes of the fourth (4<sup>th</sup>) period or the last two (2) minutes of each extra period.

19.2.3 A substitution opportunity **ends** when the ball is at the disposal of a player for a throw-in or a first or only free throw.

19.2.4 A player who has become a substitute and a substitute who has become a player cannot respectively re-enter the game or leave the game until the ball becomes dead again, after a clock-running phase of the game, unless:

- The team is reduced to fewer than five (5) players on the playing court.

- The player entitled to the free-throws as the result of the correction of an error is on the team bench after having been legally substituted.

### 19.3 Procedure

- 19.3.1 Only a substitute has the right to request a substitution. He (not the coach or the assistant coach) shall go to the scorer's table and ask clearly for a substitution, making the proper conventional sign with his hands. He shall stay in the substitution space. He must be ready to play immediately.
- 19.3.2 A substitution request may be cancelled only before the scorer's signal has sounded for such a request.
- 19.3.3 As soon as a substitution opportunity begins the scorer shall sound his signal to notify the officials that a request for a substitution has been made.
- 19.3.4 The substitute shall remain outside the boundary line until the official gives the substitution signal and beckons him to enter the playing court.
- 19.3.5 The player being replaced is permitted to go directly to his team bench without reporting either to the scorer or the official.
- 19.3.6 Substitutions shall be completed as quickly as possible. A player who has committed his fifth (5<sup>th</sup>) foul or has been disqualified must be substituted immediately (approximately 30 seconds). If, in the judgement of the official, there is an unreasonable delay, a time-out shall be charged against the offending team. If the team has no time-out left a technical foul ('B') may be charged against the coach.
- 19.3.7 If a substitution is requested during a time-out or during an interval of play, the substitute must report to the scorer before entering the game.
- 19.3.8 If the free-throw shooter must be substituted because he:
- Is injured.
  - Has committed his fifth foul.
  - Has been disqualified.
- The free throw(s) must be attempted by his substitute who may not be substituted again until he has played in the next clock-running phase of the game.
- 19.3.9 If the request for a substitution is made by either team after the ball is at the disposal of the free-throw shooter for the first or only free throw, the substitution shall be granted if:
- The last or only free throw is successful.
  - It is followed by a throw-in from the centre line extended.
  - A foul is called between free throws. In this case the free throw(s) will be completed and the substitution will be permitted before the new foul penalty is administered.
  - A foul is called before the ball becomes live after the last or only free throw. In this case the substitution will be permitted before the new foul penalty is administered.



- A violation is called before the ball becomes live after the last or only free throw. In this case the substitution will be permitted before the throw-in is administered.

In the event of consecutive sets of free throws resulting from more than one (1) foul penalty, each set is to be treated separately.

19.3.10 **A substitution shall not be permitted** to the scoring team when the game clock is stopped following a successful field goal in the last two (2) minutes of the fourth (4<sup>th</sup>) period or the last two (2) minutes of each extra period unless:

- An official has interrupted the game.
- The non-scoring team has been granted a time-out or substitution.

19.3.11 **Once the substitution has been completed**, the classifier, if present, or the assistant scorer (see Art. 48.5), shall verify that the total points value of the team requesting the substitution does not exceed the legal limit (see Art. 51.2). If he determines that the 14 point limit rule has been exceeded he shall inform the scorer who will, in turn, inform the official by sounding his signal at the conclusion of the next phase of play if the offending teams opponents are in control of the ball, or immediately, if the offending team is in control of the ball.

## **Art. 20 Game lost by forfeit**

### **20.1 Rule**

A team shall lose the game by forfeit if:

- Fifteen (15) minutes after the scheduled starting time, the team is not present or is unable to field five (5) players within the 14-point limit rule ready to play.
- Its actions prevent the game from being played.
- It refuses to play after being instructed to do so by the referee.

### **20.2 Penalty**

20.2.1 The game is awarded to the opponents and the score shall be twenty to zero (20 to 0). Furthermore, the forfeiting team shall receive zero (0) points in the classification.

20.2.2 For a two-game (home and away) total points series and for Play-Offs (best of three), the team that forfeits in the first, second or third game shall lose the series or Play-Offs by 'forfeit'. This does not apply for Play-Offs (best of five).

## **Art. 21 Game lost by default**

### **21.1 Rule**

A team shall lose a game by default if, during the game, the team has fewer than two (2) players on the playing court ready to play.



## 21.2 Penalty

- 21.2.1 If the team to which the game is awarded is ahead, the score shall stand as at the time when the game was stopped. If the team to which the game is awarded is not ahead, the score shall be recorded as two to zero (2 to 0) in its favour. The defaulting team shall receive one (1) point in the classification.
- 21.2.2 For a two-game (home and away) total point series, the team that defaults in the first or in the second game shall lose the series by 'default'.



---

## RULE FIVE - VIOLATIONS

---

### Art. 22 Violations

#### 22.1 Definition

A **violation** is an infraction of the rules.

#### 22.2 Penalty

The ball shall be awarded to the opponents for a throw-in at the place nearest to the infraction, except directly behind the backboard, unless otherwise stated in the rules.

### Art. 23 Player out-of-bounds and ball out-of-bounds

#### 23.1 Definition

23.1.1 A **player** is out-of-bounds when any part of his body or any part of his wheelchair is in contact with the floor or any object other than a player, on, above or outside the boundary line.

23.1.2 The **ball** is out-of-bounds when it touches:

- A player, wheelchair or any other person when out-of-bounds.
- The floor or any object on, above or outside the boundary line.
- The backboard supports, the back of the backboards or any object above the playing court.

#### 23.2 Rule

23.2.1 The ball is caused to go out-of-bounds by the last player to touch or be touched by the ball before it goes out-of-bounds, even if the ball then goes out-of-bounds by touching something other than a player.

23.2.2 If the ball is out-of-bounds because of touching or being touched by a player who is on or outside the boundary line, this player causes the ball to go out-of-bounds.

23.2.3 If a player(s) move(s) to out-of-bounds or to his backcourt **during** a held ball, a tap-off situation occurs.

23.2.4 If a player deliberately throws or taps the ball onto an opponent, thus causing it to go out-of-bounds, the ball shall be awarded to the opponents, even though it was last touched by that team.

### Art. 24 Dribbling

#### 24.1 Definition

A **dribble starts** when a player, having gained control of a live ball on the playing court:

24.1.1 Pushes his wheelchair and dribbles the ball simultaneously, or



24.1.2 Alternately pushes his wheelchair and dribbles the ball. The ball shall be placed on the lap, not between the knees, while pushing the wheelchair, and one or two pushes shall be followed by one or more dribbles, or

24.1.3 Use both of the above sequences alternately.

24.1.4 A player who accidentally loses and then regains control of a live ball on the playing court is considered to be fumbling the ball.

**24.2 The following are not dribbles:**

- Successive shots for a field goal.
- Fumbling the ball at the beginning or at the end of a dribble.
- Attempts to gain control of the ball by tapping it from the vicinity of other players.
- Tapping the ball from the control of another player.
- Deflecting a pass and gaining control of the ball.
- Tossing the ball from hand to hand and allowing it to come to rest before touching the floor, provided that no travelling violation is committed.

**24.3 Rule**

A player shall not throw the ball against a backboard and touch it again before it touches another player unless, in the opinion of the official, it was a shot.

24.4 An infraction of this article is a violation.

**Art. 25 Travelling (Three pushes)**

**25.1 Definition**

25.1.1 A player may progress with a live ball on the court in any direction within the following limits:

- The number of pushes while holding the ball shall not exceed two.
- Any pivot movements shall be considered part of the dribble, and are limited to two consecutive pushes without dribbling the ball.

25.1.2 Braking a wheel without backward or forward movement of the hand(s) does not constitute a push.

25.2 An infraction of this article is a violation.

**Art. 26 Three seconds**

**26.1 Rule**

26.1.1 A player shall **not** remain in the opponent's restricted area for more than three (3) consecutive seconds while his team is in control of **a live ball on the court and the game clock is running.** (see Art.17.3.3)

26.1.2 Allowances must be made for a player who:

- Makes an attempt to leave the restricted area.



- Is in the restricted area when he or his team-mate is in the act of shooting and the ball is leaving or has just left the player's hand(s) on the shot for a field goal.
- Dribbles in the restricted area to shoot for a field goal after having been there for less than three (3) seconds.

26.1.3 To establish himself outside the restricted area, the player must place all wheels of his wheelchair and any anti-tip castor(s), which continuously come into contact with the floor outside the restricted area.

## **Art. 27 Closely guarded player**

### **27.1 Definition**

A player who is holding a live ball on the playing court is closely guarded when an opponent is in an active guarding position at a distance of no more than one (1) metre.

### **27.2 Rule**

A closely guarded player must pass, shoot or dribble the ball within five (5) seconds.

## **Art. 28 Eight seconds**

### **28.1 Definition**

28.1.1 A team's **backcourt** consists of its team's own basket, the inbounds part of the backboard and that part of the playing court limited by the endline behind the team's own basket, the sidelines and the centre line.

28.1.2 A team's **frontcourt** consists of the opponent's basket, the inbounds part of the backboard and that part of the playing court limited by the endline behind the opponent's basket, the sidelines and the inside edge of the centre line nearest to the opponent's basket.

28.1.3 The ball **goes** into a team's **frontcourt** when:

- It touches the frontcourt.
- It touches a player who has part of his wheelchair or his hand(s) or an official who has part of his body in contact with the frontcourt.

### **28.2 Rule**

28.2.1 Whenever a player gains control of a **live** ball in his **backcourt**, his team must cause the ball to go into its frontcourt within eight (8) seconds.

28.2.2 The eight (8) second period will continue with any time remaining when the team that previously had control of the ball is awarded a throw-in in the backcourt, as a result of:

- A ball having gone out-of-bounds.
- A player of the same team having been injured.
- A tap-off situation.
- A double foul.
- A cancellation of equal penalties against both teams.

- 28.2.3 The eight (8) second period will continue with any time remaining when the team that previously had control of the ball deliberately throws or taps the ball onto an opponent in the front court causing it to return to the back court.

## Art. 29 Twenty-four seconds

### 29.1 Rule

- 29.1.1 Whenever a player gains control of a **live** ball on the playing **court**, his team must attempt a shot for a field goal within twenty-four (24) seconds.

To constitute a shot for a field goal within twenty-four (24) seconds:

- The ball must leave the player's hand(s) before the twenty-four second device signal sounds, and
- After the ball has left the player's hand(s), the ball must touch the ring or enter the basket.

- 29.1.2 When a shot for a field goal is attempted near the end of the twenty-four second period and the signal sounds while the ball is in the air:

- If the ball enters the basket, no violation has occurred, the signal shall be disregarded and the goal shall count.

- 29.1.2.1 If the ball touches the ring but does not enter the basket, no violation has occurred, the signal shall be disregarded and the game shall continue.

- 29.1.2.2 If the ball hits the backboard (not the ring) or misses the ring, a violation has occurred unless the opponents have gained immediate and clear control of the ball, in which case the signal shall be disregarded and the game shall continue.

### 29.2 Procedure

- 29.2.1 If the game is **stopped** by an official for any valid reason not connected with either team (twenty-four second device reset in error, etc.) or connected with the opponents of the team in control of the ball possession of the ball shall be awarded to the team that previously had control of the ball with a new twenty-four (24) seconds.

However, if in the judgement of the officials, the opponents would be placed at a disadvantage, the twenty-four second device shall continue from the time it was interrupted.

- 29.2.2 If the twenty-four second device signal **sounds in error** while a team has control of the ball or neither team has control of the ball, the signal shall be disregarded and the game shall continue.

However, if in the judgement of the officials, the team in control of the ball has been placed at a disadvantage, the game shall be stopped, the twenty-four second device shall be corrected and the ball shall be awarded to that team.

### 29.3 Penalty



The ball shall be awarded to the opponents for a throw-in at the place nearest to where the game was stopped by the official, except directly behind the backboard.

## **Art. 30 Ball returned to the backcourt**

### **30.1 Definition**

30.1.1 The ball **goes** into a team's **backcourt** when:

- It touches the backcourt.
- It touches a player who has part of his wheelchair or his hand(s) in contact with the backcourt or an official in the backcourt.

30.1.2 The ball has been illegally returned to the backcourt when a player of the team in control of the live ball is:

- The last to touch the ball in his frontcourt, after which that player or a team-mate is the first to touch the ball in the backcourt.
- The **last** to touch the ball in his backcourt, after which the ball touches the frontcourt and then is first touched by that player or team-mate in the backcourt.

This restriction applies to **all** situations in a team's frontcourt, including throw-ins.

### **30.2 Rule**

A player who is in control of a live ball may not cause the ball to be illegally returned to his backcourt.

## **Art. 31 Lifting and Rear Wheels off the Floor**

### **31.1 Definition - Lifting**

31.1.1 **Lifting** is the act of raising the player's buttocks so that both cheeks are no longer in contact with the cushion on the wheelchair in order to gain an unfair advantage.

A player shall not lift from the wheelchair to shoot, rebound or pass the ball or attempt to block a shot or a pass from an opponent.

31.1.2 Penalty

A technical foul shall be assessed against the player.

### **31.2 Definition – Raising the rear wheels off the floor**

31.2.1 **Raising the rear wheels off the floor** - In wheelchair basketball anytime a *player who has the ball or is attempting to play the ball*, raises both rear wheels off the floor simultaneously it is either a violation or a foul. This generally happens when:

- A player reaches forward for the ball on the floor
- Makes contact with another player either from his own team or the opponent's team.
- Or rises up while strapped to the wheelchair to shoot, rebound, pass the ball or attempt to block a shot or a pass from an opponent.

### **31.3 Penalty**



31.3.1 A technical foul should be assessed against the player when

- The wheels are raised off the floor because the player has come into contact with an opponent and the contact is significant enough to be considered a foul.
- The wheels are raised off the floor when the player while strapped to the wheelchair attempts to shoot, rebound, pass the ball or attempts to block a shot or a pass from an opponent.

31.3.2 A violation should be called when

- The wheels are raised off the floor because of the player leaning forward to retrieve a ball from the floor with or without contact with another player. If contact occurs it must not be significant enough to be considered a foul.
- The wheels are raised off the floor because the player has come into contact with a player of the opponent's team and contact is not significant enough to be considered a foul.
- The wheels are raised off the floor because the player has come into contact with a player of his own team.



---

## RULE SIX - FOULS

---

### Art. 32 Fouls

#### 32.1 Definition

- 32.1.1 During a game in which ten (10) players are moving at speed in a limited space, **personal contact** cannot be avoided.
- 32.1.2 A foul is an infraction of the rules concerning illegal personal contact with an opponent or his wheelchair and/or unsportsmanlike behaviour.
- 32.1.3 NOTE: The wheelchair is considered to be part of the player.
- 32.1.4 Any number of fouls may be called against a team. Irrespective of the penalty, each foul shall be charged, entered on the scoresheet against the offender and penalised accordingly.

### Art. 33 Contact General principles

#### 33.1 Cylinder principle

The cylinder principle is defined as the space within an imaginary cylinder occupied by a player and his wheelchair on the floor. It includes the space above the player and is limited to:

- The **front** by the palms of the hands and the footrest or the horizontal bar at front of the wheelchair,
- The **rear** by the back outside edge of the large wheels, and
- The **sides** by the outside edge of the large wheels where they touch the floor.
- The hands and arms may be extended in front of the torso no further than the position of the footrest or the horizontal bar at the front of the wheelchair, with the arms bent at the elbows so that the forearms and hands are raised. The distance between the large wheels will vary according to the camber of the wheels.

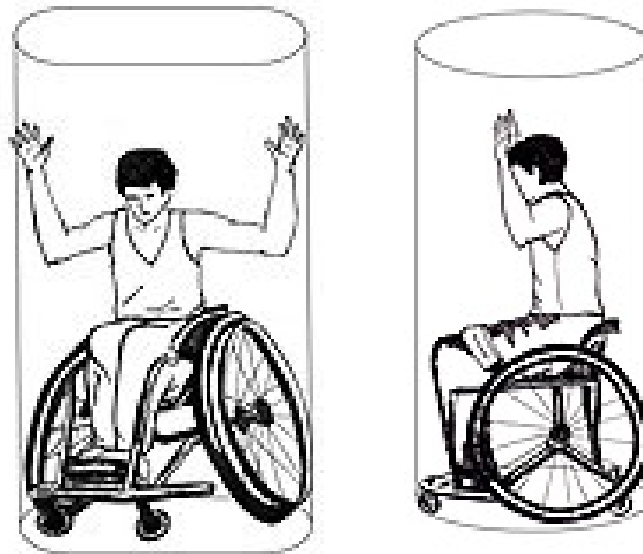

**Diagram 6 the Wheelchair Cylinder**

### **33.2 Principle of Verticality – The Wheelchair Cylinder**

On the basketball court, each player has the right to the space (cylinder) on court occupied by his wheelchair and his torso when in the upright seated position.

**Note:** The cylinder is defined as the geometrical shape formed by the player, his wheelchair with all wheels including anti-tip castor(s) in contact with the floor as viewed from above.

This principle protects the space on the floor which his wheelchair occupies and the air space above his torso and his wheelchair.

As soon as the player leaves his vertical position (cylinder) and body or wheelchair contact occurs with an opposing player who had already established his own vertical position (cylinder), the player who left his vertical position (cylinder) is responsible for the contact.

The defender must not be penalized for having his hands and arms extended above him and within his own cylinder.

The offensive player shall not cause contact with a defensive player in a legal guarding position by:

- Using his arms to create additional space for himself (clear-out)
- Spreading his arms to cause contact during or immediately after a shot for a field goal.

### **33.3 Legal Guarding Position**

A defensive player has established a legal guarding position when:

- He has covered the path of an opponent, or
- He has established a position in the path of an opponent while, at the same time, allowing that opponent time to avoid contact.
- The path of a player is the direction that the player is moving.
- The path of a player is as wide as the parallels drawn from either side of the seat of a wheelchair in the direction that the wheelchair is travelling.



Note: The parallel lines extending from either side of the seat will serve as a practical point of reference for the official. This definition does not imply that the wheels are not part of the wheelchair or part of the player.

To cover the path of an opponent, a player must position his wheelchair across the opponent's path, with his wheelchair extending from one side of the path across to the other side.

A player may not place his wheelchair between the rear wheels of an opponent's wheelchair

The legal guarding position extends upwards above the player's torso, but within the cylinder formed by the player's body and wheelchair. The player may raise his arms above his head, but he must maintain them in a position inside the imaginary cylinder.

### **33.4 Guarding a Player who Controls the Ball**

33.4.1 A player who stops in the path of a moving opponent must give the opponent time and distance to stop or change direction.

- Slight or incidental contact which disadvantages neither player may be disregarded.
- A player who covers the path of an opponent is considered to have given the opponent time and distance to avoid contact.

33.4.2 The player with the ball, while moving or stationary, must expect to be guarded and must be prepared to stop or change direction whenever an opponent takes a legal guarding position in front of him. (See article 33.4.1 for time and distance to stop or change direction).

- The guarding (defensive) player must establish a legal guarding position without causing contact prior to taking that position.
- Once a defensive player has established a legal guarding position, he must maintain this position; that is, he may not extend his arms or move his wheelchair illegally to prevent the player with the ball from passing him by.

33.4.3 **When Judging a Block/Charge situation** an official shall use the following principles:

- The defensive player must establish an initial legal guarding position by either;
  - Covering the path of the opponent, or
  - Establishing a position in the path of the opponent that allows the opponent time to avoid contact. (see also Art 33.6.4, 33.7.1, 33.8.2).
- The defensive player may remain stationary, or move laterally or backwards in order to maintain the guarding position.
- The defensive player must be on the spot first. If this defensive player has legally covered the path of the opponent, the defensive player is considered to be on the spot first.

IF THE THREE ITEMS ABOVE ARE PRESENT, THEN THE CONTACT IS CAUSED BY THE PLAYER WITH THE BALL.

### 33.5 Guarding a Player who does NOT Control the Ball

33.5.1 A player who does not control the ball is entitled to move freely on the playing court and take any position not already occupied by another player.

- In taking up a legal position close to an opponent, a player must occupy the position first.
- The defensive player must be on the spot first. The defensive player is considered to have a legal position if he reaches a spot before an opponent who does not control the ball.

33.5.2 Once a defensive player has taken a legal guarding position, he may not prevent an opponent from passing him by extending his arms into the opponent's path. He may however, in order to prevent injury, turn or place his arms in front of his body, or turn his wheelchair, providing that in turning his chair he does not, in the opinion of the official, significantly change his position in the path of the opponent.

Once a defensive player has taken a legal guarding position:

- he may remain stationary or move laterally or move away from the opponent in order to maintain his legal position in relation to the opponent.
- he may move towards his opponent; however, if contact occurs, he is responsible.

33.5.3 A defender who is stationary within a chair length of the braking area of a moving opponent who does not control the ball, and who then moves into the braking area of that opponent, must allow the opponent time and distance to avoid contact.

### 33.6 Crossing the path

33.6.1 Crossing the path occurs when one of two opponents, travelling either parallel (in the same direction) or on converging paths, changes direction and turns across into the path of the opponent.

33.6.2 A moving player with or without the ball may legally cross into the path of an opponent under the following conditions:

- The axle of the rear wheel of the player crossing the path can be seen in advance of the most forward part of the opponent's wheelchair, that is either the footrests or, in case of a chair with a forward projection located in front of the wheelchair, in front of the most forward point of that projection.
- The player who cross the path must allow the opponent time and distance to avoid contact.

33.6.3 If a player legally crosses the path of an opponent, then the opponent is responsible for contact.

33.6.4 **Illegal crossing the path** is personal contact that takes place when a player, with or without the ball, changes direction and attempts to cross into the path of an opponent without allowing that opponent time to stop or change direction.

### 33.7 The elements of Time and Distance



Coming to an immediate stop with a wheelchair is impossible.

- 33.7.1 Moving players who stop ahead of an opponent must allow sufficient distance between the wheelchairs, in order to give the opponent the opportunity to brake or to change direction without causing severe contact.

Slight contact can be regarded as incidental if a player tries **to brake or to change the direction** of his wheelchair.

The distance needed by a player to stop is directly proportional to the speed of his wheelchair.

### 33.8 Screening - Legal and Illegal

Screening is an attempt to delay or prevent an opponent without the ball from reaching a desired position on the playing court.

- 33.8.1 LEGAL screening takes place when the player who is screening an opponent:

- **Is Stationary** (inside his cylinder) when contact occurs.
- Has established a legal position on the floor.
- If the screen is set **within** the field of vision of a stationary opponent (front or lateral), the screener may establish the screen as close to him as he desires, providing there is no contact.
- If the screen is set **outside** the field of vision of a stationary opponent (frontal or lateral), the screener may establish the screen as close to him, short of contact, as he desires
- If the opponent is **in motion**, the elements of time and distance shall apply. The screener must either cover the path of the player who is being screened or leave enough space so that the player who is being screened is able to avoid the screen by stopping or changing direction.
- A player who is legally screened is responsible for any contact with the player who has set the screen.

- 33.8.2 ILLEGAL screening takes place when the player who is screening an opponent:

- Was **moving** when contact occurred.
- Did not respect the elements of time and distance of an opponent **in motion** when contact occurred.
- Failed to cover the path of the opponent

### 33.9 Charging

Charging is illegal personal contact, with or without the ball, by pushing or moving into an opposing player's wheelchair.

### 33.10 Blocking

Blocking is illegal personal contact which impedes the progress of an opponent with or without the ball.

- 33.10.1 A player who is attempting to screen is committing a blocking foul if contact occurs when he is moving and his opponent is stationary or retreating from him.

If a player disregards the ball, faces an opponent and shifts his position as the opponent shifts, he is primarily responsible for any contact that occurs, unless other factors are involved.

The expression 'unless other factors are involved' refers to deliberate pushing, charging or holding of the player who is being screened.

- 33.10.2 It is legal for a player to extend his arm(s) or elbow(s) outside of his cylinder in taking position on the floor but they must be moved inside his cylinder when an opponent attempts to go by. If the arm(s) or elbow(s) are outside his cylinder and contact occurs, it is blocking or holding.

### 33.11 Contacting an Opponent with the Hand(s) and/or Arm(s)

The touching of an opponent with a hand(s) is, in itself, not necessarily a foul.

The officials shall decide whether the player who caused the contact has gained an unfair advantage. If contact caused by a player in any way restricts the freedom of movement of an opponent, such contact is a foul.

- 33.11.1 Illegal use of the hand(s) or extended arm(s) occurs when the defensive player is in a guarding position and his hand(s) or arm(s) is placed upon and remains in contact with an opponent **with** or **without** the ball, to impede his progress.

To repeatedly touch or 'jab' an opponent with or without the ball is a foul, as it may lead to rough play.

- 33.11.2 To repeatedly touch or 'jab' an opponent with or without the ball is a foul, as it may lead to rough play.

- It is a foul by an **offensive player with the ball** to: 'Hook' or wrap an arm or an elbow around a defensive player in order to obtain an unfair advantage.
- 'Push off' to prevent the defensive player from playing or attempting to play the ball, or to create more space between himself and the defensive player.
- Use an extended forearm or hand, while dribbling, to prevent an opponent from gaining control of the ball.

- 33.11.3 It is a foul by an **offensive player without the ball** to 'push off' to:

- Get free to receive the ball.
- Prevent the defensive player from playing or attempting to play the ball.
- Create more space between himself and the defensive player.

### 33.12 Illegal guarding from the rear

Illegal guarding from the rear is personal contact with an opponent or his wheelchair, by a defensive player, from behind. The fact that the defensive player is attempting to play the ball does not justify his contact with an opponent or his wheelchair from the rear.

### 33.13 Holding



Holding is illegal personal contact with an opponent that interferes with his freedom of movement or that of his wheelchair. This contact (holding) can occur with any part of the body or the wheelchair.

### **33.14 Pushing**

Pushing is illegal personal contact with any part of the body or the wheelchair in which a player forcibly moves or attempts to move an opponent with or without control of the ball.

## **Art. 34 Personal foul**

### **34.1 Definition**

34.1.1 **A personal foul** is a player's contact foul with an opponent (which includes his wheelchair), whether the ball is live or dead.

A player shall not hold, block, push, charge or impede the progress of an opponent by extending his hand, arm, elbow, shoulder nor by bending his body into an 'abnormal' position (outside his cylinder), nor shall he indulge in any rough or violent play.

### **34.2 Penalty**

A personal foul shall be charged against the offender.

34.2.1 If the foul is committed on a player who is not in the act of shooting:

- The game shall be resumed with a throw-in by the non-offending team at the place nearest to the infraction.
- If the offending team is in a team foul penalty situation, then Art. 41 (Team fouls: Penalty) will apply.

34.2.2 If the foul is committed on a player in the act of shooting, that player shall be awarded a number of free throw(s) as follows:

- If the shot from the field goal area is successful, the goal shall count and one (1) additional free throw awarded.
- If the shot from the two-point field goal area is unsuccessful, two (2) free throws will be awarded.
- If the shot from the three-point field goal area is unsuccessful, three (3) free throws will be awarded.
- If the player is fouled as, or just before, the game clock signal sounds for the end of the period or as, or just before, the twenty-four second device signal sounds, while the ball is still in the player's hand(s) and the field goal is successful, the goal shall not count and two (2) or three (3) free throws will be awarded.
- 

## **Art. 35 Double foul**

### **35.1 Definition**

A **double foul** is a situation in which two opponents commit personal fouls against each other at approximately the same time.

## 35.2 Penalty

- 35.2.1 A personal foul shall be charged against each offender. **No** free throws shall be awarded.
- 35.2.2 The game shall be resumed as follows if at approximately the same time as the double foul:
- Valid field goal, or a last or only free throw is scored, the ball shall be awarded to the non-scoring team for a throw-in at any place at the endline.
  - A team had control of the ball or was entitled to the ball, the ball shall be awarded to this team for a throw-in at the place nearest to the infraction.
  - Neither team had control of the ball nor was entitled to the ball, a tap-off situation occurs.

## Art. 36 Unsportsmanlike foul

### 36.1 Definition

- 36.1.1 An **unsportsmanlike foul** is a player contact foul which, in the judgement of the official, is not a legitimate attempt to directly play the ball within the spirit and intent of the rules.
- 36.1.2 Unsportsmanlike fouls must be interpreted consistently throughout the whole game.
- 36.1.3 The official must judge only the action.
- 36.1.4 To judge whether a foul is unsportsmanlike, the officials should apply the following principles:
- If a player is making no effort to play the ball and contact occurs, it is an unsportsmanlike foul.
  - If a player, in an effort to play the ball, causes excessive contact (hard foul), then the contact shall be judged to be unsportsmanlike.
  - If a player commits a foul while making a legitimate effort to play the ball (normal wheelchair basketball play), it is **not** an unsportsmanlike foul.

### 36.2 Penalty

- 36.2.1 An unsportsmanlike foul shall be charged against the offender.
- 36.2.2 Free throw(s) shall be awarded to the player who was fouled, followed by:
- A throw-in at the centre line extended, opposite the scorer's table.
  - A tap-off at the centre circle to begin the first period.

The number of free throws shall be as follows:

- If the foul is committed on a player not in the act of shooting: two (2) free throws will be awarded.
- If the foul is committed on a player in the act of shooting: the goal, if made, shall count and, in addition, one (1) free throw will be awarded.
- If the foul is committed on a player in the act of shooting who fails to score: two (2) or three (3) free throws will be awarded.



## Art. 37 Disqualifying foul

### 37.1 Definition

37.1.1 A **disqualifying foul** is any flagrantly unsportsmanlike action of a player, substitute, excluded player, coach, assistant coach or team follower.

37.1.2 A player shall also be disqualified when he is charged with two (2) unsportsmanlike fouls.

37.1.3 A coach shall be also disqualified when:

- He is charged with two (2) technical fouls ('C') as a result of his personal unsportsmanlike behaviour.
- He is charged with three (3) technical fouls accumulated as a result of unsportsmanlike behaviour from the team bench ('B') (assistant coach, substitute or team follower) or a combination of three (3) technical fouls, one of which has been charged against the coach ('C').

37.1.4 If a player or coach is disqualified under Art. 37.1.2 or Art. 37.1.3, that unsportsmanlike or technical foul shall be the only foul to be penalised and **no additional** penalty for the disqualification shall be administered.

37.1.5 A coach who has been disqualified shall be replaced by the assistant coach as entered on the scoresheet. If no assistant coach is entered on the scoresheet, he shall be replaced by the captain.

37.1.6 All equipment covered under Article 3.1 shall be subject to a chair check prior to the start of the tournament, generally during the Classification Practise of each team. Equipment shall be verified to be correct by a Game Commissioner and shall be signed off as agreed to by the team manager or coach.

To alter a wheelchair not in accordance with the rules, after the chair check has been administered, is considered to be flagrantly unsportsmanlike behaviour. Referees may conduct random chair checks during a game. Any equipment found to be altered during a random check made by the referees during a game shall be removed from the game. The player is responsible for his equipment and any modification shall be considered a deliberate act to gain an unfair advantage. The player will be assessed a disqualifying foul.

### 37.2 Penalty

37.2.1 A disqualifying foul shall be charged against the offender.

37.2.2 He shall be disqualified and shall go to, and remain in, his team's dressing room for the duration of the game or, if he so chooses, he shall leave the building.

37.2.3 Free throw(s) shall be awarded:

- To any opponent in the case of a non-contact foul.
- To the player who was fouled in the case of a contact foul.

Followed by:

- A throw-in at the centre line extended, opposite the scorer's table.

- A tap-off at the centre circle to begin the first period.

37.2.4 The number of free throws shall be as follows:

- If the foul is committed on a player not in the act of shooting or if it is a technical foul: two (2) free throws will be awarded.
- If the foul is committed on a player in the act of shooting: the goal, if made, shall count and in addition one (1) free throw will be awarded.
- If the foul is committed on a player in the act of shooting who fails to score: two (2) or three (3) free throws will be awarded.

## **Art. 38 Technical foul**

### **38.1 Rules of conduct**

38.1.1 The proper conduct of the game demands the full and loyal cooperation of the members of both teams (players, substitutes, coaches, assistant coaches and team followers) with the officials, table officials and commissioner.

38.1.2 Each team shall do its best to secure victory, but this must be done in the spirit of sportsmanship and fair play.

38.1.3 Any deliberate or repeated non-cooperation or non-compliance with the spirit of this rule shall be considered as a technical foul.

38.1.4 The official may prevent technical fouls by warnings or even overlooking minor technical infractions of an administrative character which are obviously unintentional and have no direct effect upon the game, unless there is repetition of the same infraction after the warning.

38.1.5 If a technical infraction is discovered after the ball is live, the game shall be stopped and a technical foul charged. The penalty shall be administered as if the technical foul had occurred at the time it was charged. Whatever occurred during the interval between the technical infraction and the game being stopped shall be valid.

### **38.2 Violence**

38.2.1 Acts of violence may occur during the game, contrary to the spirit of sportsmanship and fair play. These should be stopped immediately by the officials and, if necessary, by public order enforcement officers.

38.2.2 Whenever acts of violence occur between players, substitutes, coaches, assistant coaches or team followers, on the playing court or in its vicinity, the officials shall take the necessary action to stop them.

38.2.3 Any of the above persons who are guilty of flagrant acts of aggression against opponents or officials shall be disqualified. The officials must report the incident to the organising body of the competition.

38.2.4 Public order enforcement officers may enter the playing court only if requested to do so by the officials. However, should spectators enter the playing court with the obvious intention of committing acts of violence, the



public order enforcement officers must intervene immediately to protect the teams and officials.

38.2.5 All other areas, including entrances, exits, hallways, dressing rooms, etc., come under the jurisdiction of the organising body of the competition and the public order enforcement officers.

38.2.6 Physical actions by players, substitutes, coaches, assistant coaches and team followers which could lead to damaging of game equipment, must not be permitted by the officials.

When behaviour of this nature is observed by the officials, the coach of the offending team shall be given a warning immediately.

Should the action(s) be repeated, a technical foul shall immediately be called on the individual(s) involved.

**Decisions made by the officials are final and cannot be contested or disregarded.**

### 38.3 Definition

38.3.1 **A technical foul is a player** non-contact foul of a behavioural nature including, but not limited to:

- Disregarding warnings by officials.
- Disrespectfully touching the officials, the commissioner, the classifier, the table officials or the team bench personnel.
- Disrespectfully communicating with the officials, the commissioner, the classifier, the table officials or the opponents.
- Using language or gestures likely to offend or incite the spectators.
- Baiting an opponent or obstructing his vision by waving his hands near his eyes.
- Delaying the game by deliberately touching the ball after it passes through the basket or by preventing a throw-in from being taken promptly.
- Falling down to fake a foul.
- Raising out of the wheelchair to gain an unfair advantage.
- Raising both rear wheels off the floor to gain an unfair advantage.
- Taking his feet off the foot rests to gain an unfair advantage.
- Using any part of the lower limb(s) to gain an unfair advantage or to steer the wheelchair.
- Using a wheelchair that contravenes Art. 3.1.

38.3.2 **A technical foul by a coach, assistant coach, substitute or team follower** is a foul for disrespectfully communicating with or touching the officials, the commissioner, the classifier, the table officials or the opponents, or an infraction of a procedural or an administrative nature.

38.3.3 A Technical foul may also occur as the result of a request by a coach to have a chair check made on a player of the opposing team. If the referee determines that the chair is illegal the player will be disqualified in accordance with Article 37.1.6. If the referee determines that the chair is legal the coach requesting the chair check shall be assessed a technical foul.

### **38.4 Penalty**

38.4.1 If a technical foul is committed:

- By a player, a technical foul shall be charged against him as a player foul and shall count as one of the team fouls.
- By a coach ('C'), assistant coach ('B'), substitute ('B') or team follower ('B'), a technical foul shall be charged against the coach and shall **not** count as one of the team fouls.

38.4.2 Two (2) free throws shall be awarded to the opponents, followed by:

- A throw-in at the centre line extended, opposite the scorer's table.
- A tap-off at the centre circle to start the first period.

### **Art. 39 Fighting**

#### **39.1 Definition**

Fighting is physical interaction between two or more opponents (players, substitutes, coaches, assistant coaches and team followers).

This article only applies to substitutes, coaches, assistant coaches and team followers who leave the confines of the team bench area during a fight or during any situation which may lead to a fight.

#### **39.2 Rule**

39.2.1 Substitutes or team followers who leave the team bench area during a fight, or during any situation which may lead to a fight, shall be disqualified.

39.2.2 Only the coach and/or assistant coach is permitted to leave the team bench area during a fight, or during any situation which may lead to a fight, to assist the officials to maintain or to restore order. In this situation, he shall not be disqualified.

39.2.3 If a coach and/or assistant coach leaves the team bench area and does not assist or attempt to assist the officials to maintain or to restore order, he shall be disqualified.

#### **39.3 Penalty**

39.3.1 Irrespective of the number of coaches, assistant coaches, substitutes or team followers disqualified for leaving the team bench area, a single technical foul ('B') shall be charged against the coach.

39.3.2 If members of both teams are disqualified under this article and there are no other foul penalties remaining for administration, the game shall be resumed as follows.

If at approximately the same time as the game was stopped because of the fighting:

- A valid field goal is scored, the ball shall be awarded to the non-scoring team for a throw-in at any place at the endline.
- A team had control of the ball or was entitled to the ball, the ball shall be awarded to this team for a throw-in at the centre line extended, opposite the scorer's table.



- Neither team has control of the ball nor was entitled to the ball, a tap-off situation occurs.
- 39.3.3 All disqualifying fouls shall be recorded as described in B.8.3 and shall not count as a team foul.
- 39.3.4 All foul penalties occurring before the fighting situation shall be dealt with in accordance with Art. 42 (Special situations).

---

## **RULE SEVEN – GENERAL PROVISIONS**

---

### **Art. 40 Five fouls by a player**

**40.1** A player who has committed five (5) fouls, personal and/or technical, shall be informed thereof by the referee and must leave the game immediately. He must be substituted within thirty (30) seconds.

**40.2** A foul by a player who has previously committed his fifth foul is considered as an excluded player's foul and it is charged and entered in the scoresheet against the coach ('B').

### **Art. 41 Team fouls: Penalty**

#### **41.1 Definition**

41.1.1 A team is in a team foul penalty situation when it has committed four (4) team fouls in a period.

41.1.2 All team fouls committed in an interval of play shall be considered to be part of the period or extra period following.

41.1.3 All team fouls committed in an extra period shall be considered as being committed in the fourth period.

#### **41.2 Rule**

41.2.1 When a team is in a team foul penalty situation, all subsequent player personal fouls committed on a player who is not in the act of shooting shall be penalised by two (2) free throws, instead of a throw-in.

41.2.2 If a personal foul is committed by a player of the team in control of the live ball, or of the team entitled to the ball, such a foul shall be penalised by a throw-in for the opponents.

### **Art. 42 Special situations**

#### **42.1 Definition**

In the same stopped-clock period which follows an infraction, **special situations** may arise when additional foul(s) are committed.

#### **42.2 Procedure**

42.2.1 All fouls shall be charged and all penalties identified.

42.2.2 The order in which all fouls occurred shall be determined.

42.2.3 All equal penalties against the teams and all double foul penalties shall be cancelled. Once the penalties have been cancelled they are considered as never having occurred.

42.2.4 The right to possession of the ball as part of the last penalty still to be administered shall cancel any prior rights to possession of the ball.



- 42.2.5 Once the ball has become live on the first or only free throw or on a throw-in, that penalty can no longer be used for cancelling another penalty.
- 42.2.6 All remaining penalties shall be administered in the order in which they were called.
- 42.2.7 If at approximately the same time as the first infraction:
- A valid field goal is scored, the ball shall be awarded to the non-scoring team for a throw-in at any place at the endline.
  - A team had control of the ball or was entitled to the ball, the ball shall be awarded to this team for a throw-in at the place nearest to the first infraction.
  - Neither team had control of the ball nor was entitled to the ball, a tap-off situation occurs.

## **Art. 43 Free throws**

### **43.1 Definition**

- 43.1.1 A free throw is an opportunity given to a player to score one (1) point, uncontested, from a position behind the free-throw line and inside the semicircle.
- 43.1.2 A set of free throws is defined as all free throws and/or subsequent possession of the ball resulting from a single foul penalty.

### **43.2 Rule**

- 43.2.1 When a personal foul is called and the penalty is the awarding of a free throw(s):
- The player against whom the foul was committed shall attempt the free throw(s).
  - If there is a request for him to be substituted, he must attempt the free throw(s) before leaving the game.
  - If he must leave the game due to injury, having committed his fifth foul or having been disqualified, his substitute shall attempt the free throw(s). If no substitute is available, any team-mate shall attempt the free throw(s).
- 43.2.2 When a technical foul is called, any member of the opponent's team shall attempt the free throw(s).
- 43.2.3 The free-throw shooter shall:
- Take a position with his rear wheels behind the free-throw line and inside the semicircle. His front wheel(s) (or castor(s)) may be in advance of the line.
  - Use any method to shoot a free throw in such a way that the ball enters the basket from above or the ball touches the ring.
  - Release the ball within five (5) seconds of the time when it is placed at his disposal by the official.
  - Not touch the free-throw line or enter the restricted area with any part of his body or either of his rear wheels until the ball has entered the basket or has touched the ring.





- Point, if made, shall not count.
- Any other player's violation, which occurs immediately before, at approximately the same time as, or after the violation committed by the free-throw shooter, shall be disregarded.

The ball shall be awarded to the opponents for a throw-in at the free-throw line extended unless there is a further free throw(s) or possession penalty to be administered.

43.3.2 If a **free throw is successful** and the violation(s) is committed by any player(s) other than the free-throw shooter:

- Point(s), if made, shall count.
- Violation(s) shall be disregarded.

In case of the last or only free throw, the ball shall be awarded to the opponents for a throw-in at any place at the endline.

43.3.3 If a free throw is not successful and the violation is committed by:

- A **team-mate** of the free-throw shooter on the last or only free throw, the ball shall be awarded to the opponents for a throw-in at the free-throw line extended unless that team is entitled to further possession.
- An **opponent** of the free-throw shooter, a substitute free throw shall be awarded to the free-throw shooter.
- **Both teams**, on the last or only free throw, the game shall be resumed with a tap-off situation.

## Art. 44 Correctable errors

### 44.1 Definition

Officials may correct an error if a rule is inadvertently disregarded in the following situations only:

- Awarding an unmerited free throw(s).
- Failure to award a merited free throw(s).
- Erroneous awarding or cancelling of a point(s).
- Permitting the wrong player to attempt a free throw(s).

### 44.2 Procedure

44.2.1 To be correctable, the above-mentioned errors must be recognized by the officials, commissioner, or table officials before the ball becomes live following the first dead ball after the game clock has started following the error.

44.2.2 An official may stop the game immediately upon discovering a correctable error, as long as neither team is placed at a disadvantage.

44.2.3 Any fouls committed, points scored, time used and additional activity, which may have occurred after the error has occurred and **before** its recognition, shall **not** be nullified.

44.2.4 If the error constitutes an unmerited free throw(s), the free throw(s) attempted as a result of the error shall be cancelled and the game shall be resumed as follows:

- If the game clock has not started after the error, the ball shall be awarded for a throw-in to the team whose free throws had been cancelled.
  - If the game clock has started after the error and:
    - The team in control of the ball (or entitled to the ball) at the time the error is discovered is the same team that was in control of the ball at the time the error occurred, or
    - Neither team is in control of the ball at the time the error is discovered,
    - The ball shall be awarded to the team entitled to the ball at the time of the error.
  - If the game clock has started and, at the time the error is discovered, the team in control of the ball (or entitled to the ball) is the opponent of the team that was in control of the ball at the time of the error, a tap-off situation occurs.
  - If the game clock has started and, at the time the error is discovered, a foul penalty involving a free throw(s) has been awarded, the free throw(s) shall be administered and the ball shall be awarded for a throw-in to the team that was in control of the ball at the time the error occurred.
- 44.2.5 If the error constitutes a failure to award a merited free throw(s):
- If there has been no change in possession of the ball since the error was made, the game shall be resumed after correction of the error as after any normal free throw.
  - If the same team scores after having been erroneously awarded possession of the ball for a throw-in, the error shall be disregarded.
- 44.2.6 After the correction of an erroneous awarding or canceling a score, the game shall be restarted at the point at which it was interrupted to correct the error, by the team entitled to the ball at the time the game was stopped for the correction.
- 44.2.7 If the error constitutes the wrong player attempting a free throw(s), the free throw(s) attempted as a result of the error shall be cancelled and the ball shall be awarded to the opponents for a throw-in at the free throw line extended.
- 44.2.8 Once an error that is still correctable has been discovered:
- If the player involved in the correction of the error is on the team bench after having been legally substituted (**not** for having been disqualified or having committed his fifth foul), he must **re-enter** the playing court to participate in the correction of the error (at this point he becomes a player).  
Upon completion of the correction, he may remain in the game **unless** a legal substitution has been requested again, in which case the player may leave the playing court.
  - If the player was substituted because he had committed his fifth foul or was disqualified, his substitute must participate in the correction of the error.



- 44.2.9 Correctable errors cannot be corrected after the referee has signed the scoresheet.
- 44.2.10 Any errors in scorekeeping by the scorer or time-keeping by the timer involving the score, number of fouls, number of time-outs or time consumed or omitted, may be corrected by the officials at any time before the referee signs the scoresheet.



---

## **RULE EIGHT – OFFICIALS, TABLE OFFICIALS, COMMISSIONER: DUTIES AND POWERS**

---

### **Art. 45 Officials, table officials and commissioner**

- 45.1** The **officials** shall be a referee and one or two umpire(s). They shall be assisted by the table officials and by a commissioner and a classifier if present.
- 45.2** The **table officials** shall be a scorer, an assistant scorer, a timer and a twenty-four second operator.
- 45.3** A **commissioner**, if present shall sit between the scorer and the time. His primary duty during the game is to supervise the work of the table officials and to assist the referee and umpire(s) in the smooth functioning of the game. The classifier if present will sit between the commissioner and the timekeeper.
- 45.4** The officials of a given game should not be connected in any way with either team on the playing court.
- 45.5** **The officials, the table officials and the commissioner shall conduct the game in accordance with these rules and have no authority to change them.**
- 45.6** The officials' uniform shall consist of an officials' shirt, long black trousers, black socks and black basketball shoes.
- 45.7** The officials and table officials shall be uniformly dressed.

### **Art. 46 Referee: Duties and powers**

The referee shall:

- 46.1** Inspect and approve all equipment to be used during the game.
- 46.2** Designate the official game clock, twenty-four second device, stopwatch and recognise the table officials.
- 46.3** Select a game ball from at least two (2) used balls provided by the home team. Should neither of these balls be suitable as the game ball, he may select the best quality ball available.
- 46.4** Not permit any player to wear objects which may cause injury to other players.
- 46.5** Administer a tap-off to start the first period and a throw-in to start all other periods.
- 46.6** Have the power to stop a game when conditions warrant it.
- 46.7** Have the power to determine that a team shall forfeit the game.
- 46.8** Carefully examine the scoresheet at the end of playing time or at any time he feels is necessary.
- 46.9** Approve and sign the scoresheet at the end of playing time, **terminating** the officials' administration and **connection** with the game. The officials' **power** shall **begin** when they arrive on the playing court twenty (20)



minutes before the game is scheduled to begin, and **end** with the end of the playing time as approved by the officials.

- 46.10** Record, on the reverse side of the scoresheet, before signing it, any forfeit or unsportsmanlike behaviour by players, coaches, assistant coaches or team followers that occurs prior to the twenty (20) minutes before the game is scheduled to begin, or between the end of playing time and the approval and signing of the scoresheet. In such a case, the referee (commissioner, if present) must send a detailed report to the organising body of the competition.
- 46.11** Make the final decision whenever necessary or when the officials disagree. To make a final decision he may consult the umpire, the commissioner and/or the table officials.
- 46.12** Be authorized to use the technical equipment to decide, before he signs the scoresheet, if a last shot at the end of each period or any extra period was released during playing.
- 46.13** Conduct random checks of the wheelchair(s) to ensure that the teams are complying with Art. 3.1:
- If they have reason to believe a chair may be illegal or
  - If requested by a coach from one of the participating teams.
- 46.14** **Have the power to make decisions on any point not specifically covered by these rules.**

#### **Art. 47 Officials: Duties and powers**

- 47.1** The officials shall have the power to make decisions on infractions of the rules committed either within or outside the boundary line including the scorer's table, the team benches and the areas immediately behind the lines.
- 47.2** The officials blow their whistles when an infraction of the rules occurs, a period ends or the officials find it necessary to interrupt the game. The officials shall not blow their whistles after a successful field goal, a successful free throw or when the ball becomes live.
- 47.3** When deciding on a personal contact or violation, the officials shall, in each instance, have regard to and weigh the following fundamental principles:
- The spirit and intent of the rules and the need to uphold the integrity of the game.
  - Consistency in the application of the concept of 'advantage/disadvantage', whereby the officials should not seek to interrupt the flow of the game unnecessarily in order to penalise personal contact that is incidental and which does not give the player responsible an advantage nor place his opponent at a disadvantage. In wheelchair basketball, slight contact can be regarded as incidental if a player tries to brake or to change the direction of his wheelchair.
  - Consistency in the application of common sense to each game, bearing in mind the abilities of the players concerned and their attitude and conduct during the game.
  - Consistency in the maintenance of a balance between game control and game flow, having a 'feeling' for what the participants are trying to do and calling what is right for the game.



- 47.4** Should a protest be filed by one of the teams, the referee (commissioner, if present) shall, within the hour following the end of playing time, report the protest to the organising body of the competition.
- 47.5** If an official is injured or for any other reason cannot continue to perform his duties within five (5) minutes of the incident, the game shall be resumed. The other official will officiate alone until the end of the game, unless there is the possibility of replacing the injured official with a qualified substitute official. After consulting with the commissioner, the other official will decide upon the possible replacement.
- 47.6** For all international games, if verbal communication is necessary to make a decision clear, it shall be conducted in English.
- 47.7** **Each official has the power to make decisions within the limits of his duties, but has no authority to disregard or question decisions made by the other official(s).**

**Art. 48 Scorer, assistant scorer and Classifier: Duties**

- 48.1** The **scorer** shall be provided with a scoresheet and shall keep a record of:
- Teams, by entering the names and numbers of the players who are to start the game and of all substitutes who enter the game. When there is an infraction of the rules regarding the five (5) players to start the game, substitutions or numbers of players, he shall notify the nearest official as soon as possible.
  - Running summary of points scored, by entering the field goals and the free throws made.
  - Fouls charged against each player. The scorer must notify an official immediately when a fifth foul is charged against any player. He shall record the fouls charged against each coach and must notify an official immediately when a coach should be disqualified. Similarly, he must notify an official immediately when a player has committed two (2) unsportsmanlike fouls and should be disqualified.
  - Time-outs. He must notify the officials of the next time-out opportunity when a team has requested a time-out and notify the coach through an official when the coach has no more time-outs left in a half or extra period.
  - The next alternating possession, by operating the alternating possession arrow. The scorer shall adjust the direction of the alternating possession arrow immediately after the end of the first half as the team shall exchange baskets for the second half.
- 48.2** The **scorer** shall also:
- Indicate the number of fouls committed by each player by raising, in a manner visible to both coaches, the marker with the number of fouls committed by that player.
  - Position the team foul marker on the scorer's table, at the end nearest to the bench of the team in a team foul penalty situation, when the ball becomes live following the fourth team foul in a period.
  - Effect substitutions.



- Sound his signal **only** when the ball is dead and before the ball becomes live again. The sound of his signal does **not** stop the game clock or the game nor cause the ball to become dead.

**48.3** The **assistant scorer** shall operate the scoreboard and assist the scorer. In the case of any discrepancy between the scoreboard and the scoresheet which cannot be resolved, the scoresheet shall take precedence and the scoreboard shall be corrected accordingly.

**48.4** If a scorekeeping error is discovered:

- During the game, the scorer must wait for the first dead ball before sounding his signal.
- After the end of the playing time and before the scoresheet has been signed by the referee, the error shall be corrected, even if this correction influences the final result of the game.
- After the scoresheet has been signed by the referee, the error may no longer be corrected. The referee must send a detailed report to the organising body of the competition.

**48.5** The classifier or the assistant scorer shall assist the scorer by verifying the correctness of the total number of classification points of a team's five players on court. Should a team exceed the 14 point limit rule (see Art. 51.2), the classifier or the assistant scorer shall notify the scorer who shall, in turn, inform the referee and a technical foul will be charged against the coach of the offending team.

#### **Art. 49 Timer: Duties**

**49.1** The timer shall be provided with a game clock and a stopwatch and shall:

- Measure playing time, time-outs and intervals of play.
- Ensure that a signal sounds very loudly and automatically at the end of playing time in a period.
- Use any means possible to notify the officials immediately if his signal fails to sound or is not heard.
- Notify the teams and the officials at least three (3) minutes before the third period is to start.

**49.2** The timer shall measure **playing time** as follows:

- Starting the game clock when:
  - During a tap-off, the ball is legally tapped by a player involved in the tap-off.
  - After a last or only free throw is unsuccessful and the ball continues to be live, the ball touches or is touched by a player on the playing court.
  - During a throw-in, the ball touches or is touched by a player on the playing court.
- Stopping the game clock when:
  - Time expires at the end of playing time for a period.
  - An official blows his whistle while the ball is live.



- A field goal is scored against a team which has requested a time-out.
- A field goal is scored in the last two (2) minutes of the fourth period and in the last two (2) minutes of any extra period.
- The twenty-four second device signal sounds while a team is in control of the ball.

**49.3** The timer shall measure a **time-out** as follows:

- Starting the timing device immediately when the official gives the time-out signal.
- Sounding his signal when fifty (50) seconds of the time-out have elapsed.
- Sounding his signal when the time-out has ended.

**49.4** The timer shall measure an **interval of play** as follows:

- Starting the timing device immediately when a previous period has ended.
- Sounding his signal before the first and third period when three (3) minutes, one (1) minute and thirty (30) seconds remain until the beginning of the period.
- Sounding his signal before the second, fourth and each extra period when thirty (30) seconds remain until the beginning of the period.
- Sounding his signal and simultaneously stopping the timing device immediately when an interval of play has ended.

#### **Art. 50 Twenty-four second operator: Duties**

The twenty-four second operator shall be provided with a twenty-four second device and operate it so that it shall be:

**50.1 Started or restarted** whenever a team gains control of a live ball on the playing court.

**50.2 Stopped and reset** to twenty-four (24) seconds, with no display visible, as soon as:

- An official blows his whistle for a foul or violation.
- A ball on a shot for a field goal or on a pass enters the basket.
- A shot for a field goal touches the ring unless the ball lodges on the basket support.
- The game is stopped because of an action connected with the team not in control of the ball.
- The game is stopped because of an action not connected with either team, unless the opponents would be placed at a disadvantage.

**50.3 Reset** to twenty-four (24) seconds with the display visible and restarted as soon as a team gains control of a live ball on the playing court.

The mere touching of the ball by an opponent does not start a new twenty-four second period if the other team remains in control of the ball.



**50.4** **Stopped, but not reset** to twenty-four (24) seconds, when the same team that previously had control of the ball is awarded a throw-in as a result of:

- A ball having gone out-of-bounds.
- A player of the same team having been injured.
- A tap-off situation.
- A double foul.
- A cancellation of equal penalties against the teams.
- 

**50.5** **Stopped and switched off** when a team gains control of a live ball on the playing court, and there are fewer than twenty-four (24) seconds remaining on the game clock in any period.

The twenty-four second device signal does not stop the game clock or the game, nor cause the ball to become dead, unless a team is in a control of the ball.

---

## RULE 9 - PLAYER CLASSIFICATION SYSTEM

---

### Art. 51 Player Classification Points System

#### 51.1 Definition

51.1.1 In order to play in a Main Official Competition of IWBF each player must be in possession of an Official Player Classification ID card issued by the Player Classification Commission of IWBF. Player Classification ID cards may be issued at an official tournament by the Player Classification Panel appointed by IWBF based on the observations of the classifiers in accordance with the principles contained in the Official Player Classification Handbook. This ID card contains among other things the point value the player has been assigned. Under the Regulations for Player Classification this point value can change during the tournament up until the Play-off round. It is the responsibility of the Classifier at the scorer's table to determine the validity of the ID card and correct point value assigned to the player.

The valid player classifications in the IWBF are 1.0, 1.5, 2.0, 2.5, 3.0, 3.5, 4.0 and 4.5.

51.2 At no time in a game shall a team have players participating whose total points value exceed the 14-point limit.

**Note:** This total shall apply to the official competitions of IWBF as listed here. Variations in the points total may apply in other competitions.

- The main official competitions of IWBF:
- The World Championship for Men.
- The World Championship for Women.
- The Paralympic Tournaments for Men and Women.
- The World Championship for Junior Men.
- The Qualification tournaments for the World Championships for men, women & junior men.
- The Paralympic Qualifying Tournaments for Men and Women.

#### 51.3 Penalty





If, at any time during a game, a team exceeds the 14-point limit, a technical foul will be charged to the coach with a correction in the line-up to be made at the same time.

## A - OFFICIALS' SIGNALS





A.1 The hand signals illustrated in these rules are the only official signals. They must be used by all officials in all games.

A.2 It is important that the table officials are also familiar with these signals.





### I. SCORING

<p>1 ONE POINT</p>  <p>One finger, 'flag' from wrist</p>	<p>2 TWO POINTS</p>  <p>Two fingers, 'flag' from wrist</p>	<p>3 THREE-POINTS ATTEMPT</p>  <p>Three fingers (extended)</p>	<p>4 THREE-POINTS SUCCESSFUL SHOT</p>  <p>Three fingers (extended) on each hand</p>	<p>5 CANCEL SCORE OR CANCEL PLAY</p>  <p>Scissor-like action with arms, once across chest</p>
---	---	---	---	--







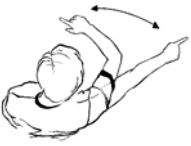

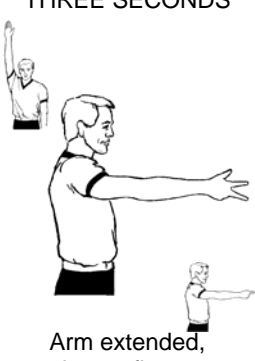

### II. CLOCK-RELATED

<p>6 STOP CLOCK (blowing whistle simultaneously) OR DO NOT START CLOCK</p>  <p>Open palm</p>	<p>7 STOP CLOCK FOR FOUL (blowing whistle simultaneously)</p>  <p>One clenched fist, other palm down pointing to offender's waist</p>	<p>8 TIME IN</p>  <p>Chop with hand</p>	<p>9 TWENTY-FOUR SECOND RESET</p>  <p>Rotate hand, index finger extended</p>
---	--	--	---

### III. ADMINISTRATIVE

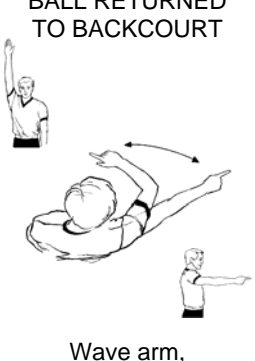











<p>10 SUBSTITUTION (blowing the whistle simultaneously)</p>  <p>Cross forearms</p>	<p>11 BECKONING-IN</p>  <p>Open palm, wave towards the body</p>	<p>12 CHARGED TIME-OUT (blowing whistle simultaneously)</p>  <p>Form T, index finger showing</p>	<p>13 COMMUNICATION BETWEEN OFFICIALS AND TABLE OFFICIALS</p>  <p>Thumb up</p>	<p>14 VISIBLE COUNT (Five and eight seconds)</p>  <p>Fingers showing counting</p>
---	--	---	--	--

#### IV. TYPE OF VIOLATIONS









<p>15 TRAVELLING (3 PUSHES)</p>  <p>Rotate fists</p>	<p>16 TOUCHING FLOOR WITH FEET OR FOOTREST BAR</p>  <p>Push hands down</p>	<p>17 CARRYING THE BALL</p> <p>NOT APPLICABLE</p>	<p>18 THREE SECONDS</p>  <p>Arm extended, show 3 fingers</p>
<p>19 FIVE SECONDS</p>  <p>Show 5 fingers</p>	<p>20 EIGHT SECONDS</p>  <p>Show 8 fingers</p>	<p>21 TWENTY-FOUR SECONDS</p>  <p>Fingers touch shoulder</p>	<p>22 BALL RETURNED TO BACKCOURT</p>  <p>Wave arm, index finger pointing</p>
<p>23 DELIBERATE FOOT BALL</p>  <p>Point finger to the foot</p>	<p>24 OUT-OF-BOUNDS AND/OR DIRECTION OF PLAY</p>  <p>Point finger parallel to sidelines</p>	<p>25 TAP-OFF SITUATION</p>  <p>Thumbs up followed by point finger in direction of possession arrow</p>	

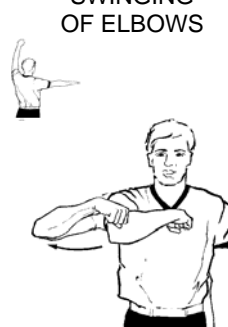
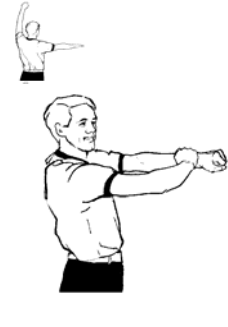

## V. REPORTING A FOUL TO THE SCORER'S TABLE (3 Steps)

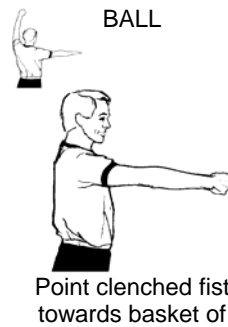
### STEP 1 - NUMBER OF PLAYER



26 No. 4 	27 No. 5 	28 No. 6 	29 No. 7 
30 No. 8 	31 No. 9 	32 No. 10 	33 No. 11 
34 No. 12 	35 No. 13 	36 No. 14 	37 No. 15 

**STEP 2 - TYPE OF FOUL**

<p>38 <b>ILLEGAL USE OF HANDS</b></p>  <p>Strike wrist</p>	<p>39 <b>BLOCKING</b> (offence or defence)</p>  <p>Both hands on hips</p>	<p>40 <b>EXCESSIVE SWINGING OF ELBOWS</b></p>  <p>Swing elbow backwards</p>	<p>41 <b>HOLDING</b></p>  <p>Grasp wrist downward</p>
<p>42 <b>PUSHING OR CHARGING WITHOUT THE BALL</b></p>  <p>Imitate push</p>	<p>43 <b>CHARGING WITH THE BALL</b></p>  <p>Clenched fist, strike open palm</p>	<p>44 <b>BY TEAM IN CONTROL OF THE BALL</b></p>  <p>Point clenched fist towards basket of offending team</p>	<p>45 <b>DOUBLE</b></p>  <p>Wave clenched fists</p>
<p>46 <b>TECHNICAL</b></p>  <p>Form T, palm showing</p>	<p>47 <b>UNSPORTSMANLIKE</b></p>  <p>Grasp wrist upward</p>	<p>48 <b>DISQUALIFYING</b></p>  <p>Clenched fists</p>	

<p>49</p> <p>LIFTING</p>  <p>Imitate lifting with hands</p>	<p>50</p> <p>CROSSING TOO EARLY IN OPPONENT'S PATH</p>  <p>Imitate movement of wheelchair with fists</p>
--	--

**STEP 3 - NUMBER OF FREE THROW(S) AWARDED**

<p>51</p> <p>ONE FREE THROW</p>  <p>Hold up 1 finger</p>	<p>52</p> <p>TWO FREE THROWS</p>  <p>Hold up 2 fingers</p>	<p>53</p> <p>THREE FREE THROWS</p>  <p>Hold up 3 fingers</p>
--	--	---

**OR**  
**- DIRECTION OF PLAY**

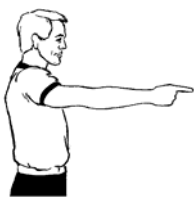
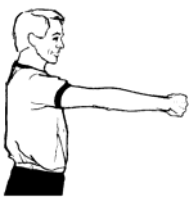
<p>54</p>  <p>Point finger, arm parallel to sidelines</p>	<p>55</p> <p>AFTER FOUL BY TEAM IN CONTROL OF THE BALL</p>  <p>Clenched fist, arm parallel to sidelines</p>
--	--

## VI. FREE-THROW ADMINISTRATION (2 Steps)

### STEP 1 - INSIDE THE RESTRICTED AREA

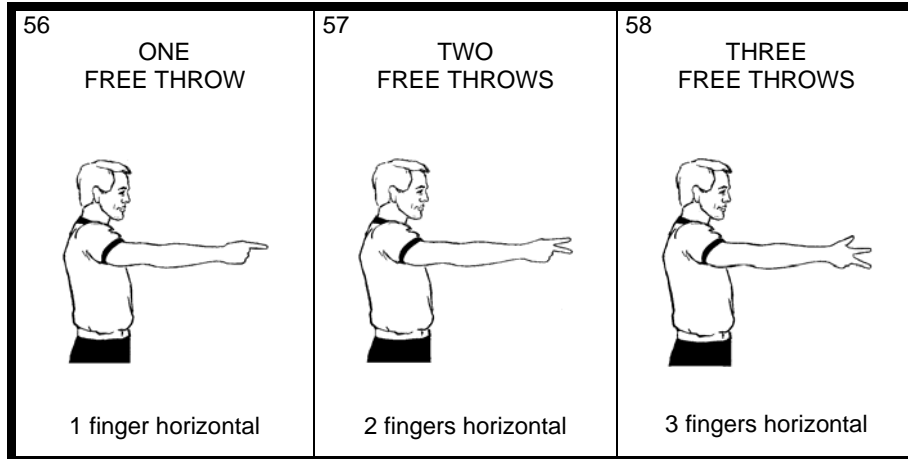

### STEP 2 - OUTSIDE THE RESTRICTED AREA

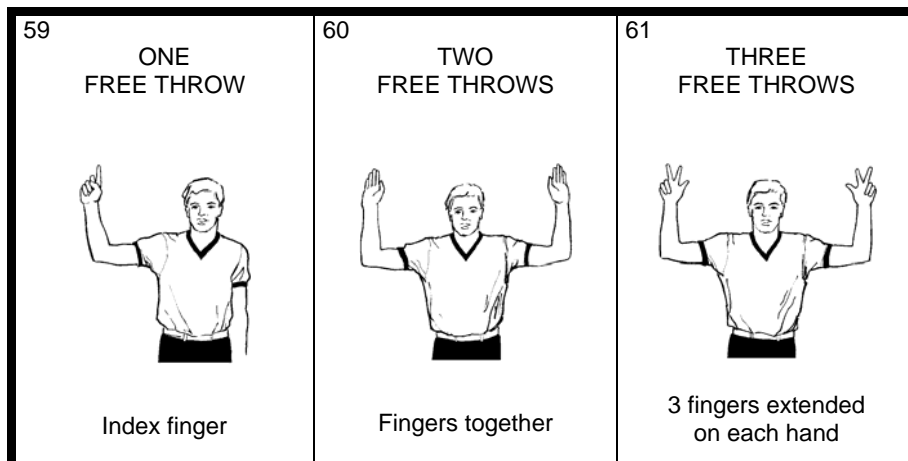

Diagram 8 Officials' signals



**B - THE SCORESHEET**



**INTERNATIONAL WHEELCHAIR BASKETBALL FEDERATION**

**SCORESHEET**

<b>Team A:</b>		<b>Team B:</b>																																																																																																																																																																																																																																																																																																																																																																																																																																																																			
Competition: _____ Date: _____ Time: _____ Referee: _____		Game No: _____ Place: _____ Umpire 1: _____ Umpire 2: _____																																																																																																																																																																																																																																																																																																																																																																																																																																																																			
<b>Team A:</b> Time-outs I <table border="1" style="display: inline-table; border-collapse: collapse;"><tr><td style="width: 20px; height: 20px;"></td><td style="width: 20px; height: 20px;"></td><td style="width: 20px; height: 20px;"></td><td style="width: 20px; height: 20px;"></td></tr></table> Period 1 <table border="1" style="display: inline-table; border-collapse: collapse;"><tr><td style="width: 20px; height: 20px;">1</td><td style="width: 20px; height: 20px;">2</td><td style="width: 20px; height: 20px;">3</td><td style="width: 20px; height: 20px;">4</td></tr></table> 2 <table border="1" style="display: inline-table; border-collapse: collapse;"><tr><td style="width: 20px; height: 20px;">1</td><td style="width: 20px; height: 20px;">2</td><td style="width: 20px; height: 20px;">3</td><td style="width: 20px; height: 20px;">4</td></tr></table> II <table border="1" style="display: inline-table; border-collapse: collapse;"><tr><td style="width: 20px; height: 20px;"></td><td style="width: 20px; height: 20px;"></td><td style="width: 20px; height: 20px;"></td><td style="width: 20px; height: 20px;"></td></tr></table> Period 3 <table border="1" style="display: inline-table; border-collapse: collapse;"><tr><td style="width: 20px; height: 20px;">1</td><td style="width: 20px; height: 20px;">2</td><td style="width: 20px; height: 20px;">3</td><td style="width: 20px; height: 20px;">4</td></tr></table> 4 <table border="1" style="display: inline-table; border-collapse: collapse;"><tr><td style="width: 20px; height: 20px;">1</td><td style="width: 20px; height: 20px;">2</td><td style="width: 20px; height: 20px;">3</td><td style="width: 20px; height: 20px;">4</td></tr></table> <table border="1" style="display: inline-table; border-collapse: collapse;"><tr><td style="width: 20px; height: 20px;"></td><td style="width: 20px; height: 20px;"></td><td style="width: 20px; height: 20px;"></td></tr></table> Extra periods						1	2	3	4	1	2	3	4					1	2	3	4	1	2	3	4				<b>RUNNING SCORE</b>																																																																																																																																																																																																																																																																																																																																																																																																																																								
1	2	3	4																																																																																																																																																																																																																																																																																																																																																																																																																																																																		
1	2	3	4																																																																																																																																																																																																																																																																																																																																																																																																																																																																		
1	2	3	4																																																																																																																																																																																																																																																																																																																																																																																																																																																																		
1	2	3	4																																																																																																																																																																																																																																																																																																																																																																																																																																																																		
<table border="1" style="width: 100%; border-collapse: collapse;"> <thead> <tr> <th rowspan="2">Class. no.</th> <th rowspan="2">Players</th> <th rowspan="2">No.</th> <th rowspan="2">Player in</th> <th colspan="5">Fouls</th> </tr> <tr> <th>1</th> <th>2</th> <th>3</th> <th>4</th> <th>5</th> </tr> </thead> <tbody> <tr><td> </td><td> </td><td>4</td><td> </td><td> </td><td> </td><td> </td><td> </td><td> </td></tr> <tr><td> </td><td> </td><td>5</td><td> </td><td> </td><td> </td><td> </td><td> </td><td> </td></tr> <tr><td> </td><td> </td><td>6</td><td> </td><td> </td><td> </td><td> </td><td> </td><td> </td></tr> <tr><td> </td><td> </td><td>7</td><td> </td><td> </td><td> </td><td> </td><td> </td><td> </td></tr> <tr><td> </td><td> </td><td>8</td><td> </td><td> </td><td> </td><td> </td><td> </td><td> </td></tr> <tr><td> </td><td> </td><td>9</td><td> </td><td> </td><td> </td><td> </td><td> </td><td> </td></tr> <tr><td> </td><td> </td><td>10</td><td> </td><td> </td><td> </td><td> </td><td> </td><td> </td></tr> <tr><td> </td><td> </td><td>11</td><td> </td><td> </td><td> </td><td> </td><td> </td><td> </td></tr> <tr><td> </td><td> </td><td>12</td><td> </td><td> </td><td> </td><td> </td><td> </td><td> </td></tr> <tr><td> </td><td> </td><td>13</td><td> </td><td> </td><td> </td><td> </td><td> </td><td> </td></tr> <tr><td> </td><td> </td><td>14</td><td> </td><td> </td><td> </td><td> </td><td> </td><td> </td></tr> <tr><td> </td><td> </td><td>15</td><td> </td><td> </td><td> </td><td> </td><td> </td><td> </td></tr> </tbody> </table> Coach: _____ Assistant coach: _____		Class. no.	Players	No.	Player in	Fouls					1	2	3	4	5			4									5									6									7									8									9									10									11									12									13									14									15							<table border="1" style="width: 100%; border-collapse: collapse;"> <thead> <tr> <th>A</th><th>B</th><th>A</th><th>B</th><th>A</th><th>B</th><th>A</th><th>B</th> </tr> </thead> <tbody> <tr><td>1</td><td>1</td><td>41</td><td>41</td><td>81</td><td>81</td><td>121</td><td>121</td></tr> <tr><td>2</td><td>2</td><td>42</td><td>42</td><td>82</td><td>82</td><td>122</td><td>122</td></tr> <tr><td>3</td><td>3</td><td>43</td><td>43</td><td>83</td><td>83</td><td>123</td><td>123</td></tr> <tr><td>4</td><td>4</td><td>44</td><td>44</td><td>84</td><td>84</td><td>124</td><td>124</td></tr> <tr><td>5</td><td>5</td><td>45</td><td>45</td><td>85</td><td>85</td><td>125</td><td>125</td></tr> <tr><td>6</td><td>6</td><td>46</td><td>46</td><td>86</td><td>86</td><td>126</td><td>126</td></tr> <tr><td>7</td><td>7</td><td>47</td><td>47</td><td>87</td><td>87</td><td>127</td><td>127</td></tr> <tr><td>8</td><td>8</td><td>48</td><td>48</td><td>88</td><td>88</td><td>128</td><td>128</td></tr> <tr><td>9</td><td>9</td><td>49</td><td>49</td><td>89</td><td>89</td><td>129</td><td>129</td></tr> <tr><td>10</td><td>10</td><td>50</td><td>50</td><td>90</td><td>90</td><td>130</td><td>130</td></tr> <tr><td>11</td><td>11</td><td>51</td><td>51</td><td>91</td><td>91</td><td>131</td><td>131</td></tr> <tr><td>12</td><td>12</td><td>52</td><td>52</td><td>92</td><td>92</td><td>132</td><td>132</td></tr> <tr><td>13</td><td>13</td><td>53</td><td>53</td><td>93</td><td>93</td><td>133</td><td>133</td></tr> <tr><td>14</td><td>14</td><td>54</td><td>54</td><td>94</td><td>94</td><td>134</td><td>134</td></tr> <tr><td>15</td><td>15</td><td>55</td><td>55</td><td>95</td><td>95</td><td>135</td><td>135</td></tr> <tr><td>16</td><td>16</td><td>56</td><td>56</td><td>96</td><td>96</td><td>136</td><td>136</td></tr> <tr><td>17</td><td>17</td><td>57</td><td>57</td><td>97</td><td>97</td><td>137</td><td>137</td></tr> <tr><td>18</td><td>18</td><td>58</td><td>58</td><td>98</td><td>98</td><td>138</td><td>138</td></tr> <tr><td>19</td><td>19</td><td>59</td><td>59</td><td>99</td><td>99</td><td>139</td><td>139</td></tr> <tr><td>20</td><td>20</td><td>60</td><td>60</td><td>100</td><td>100</td><td>140</td><td>140</td></tr> <tr><td>21</td><td>21</td><td>61</td><td>61</td><td>101</td><td>101</td><td>141</td><td>141</td></tr> <tr><td>22</td><td>22</td><td>62</td><td>62</td><td>102</td><td>102</td><td>142</td><td>142</td></tr> <tr><td>23</td><td>23</td><td>63</td><td>63</td><td>103</td><td>103</td><td>143</td><td>143</td></tr> <tr><td>24</td><td>24</td><td>64</td><td>64</td><td>104</td><td>104</td><td>144</td><td>144</td></tr> <tr><td>25</td><td>25</td><td>65</td><td>65</td><td>105</td><td>105</td><td>145</td><td>145</td></tr> <tr><td>26</td><td>26</td><td>66</td><td>66</td><td>106</td><td>106</td><td>146</td><td>146</td></tr> <tr><td>27</td><td>27</td><td>67</td><td>67</td><td>107</td><td>107</td><td>147</td><td>147</td></tr> <tr><td>28</td><td>28</td><td>68</td><td>68</td><td>108</td><td>108</td><td>148</td><td>148</td></tr> <tr><td>29</td><td>29</td><td>69</td><td>69</td><td>109</td><td>109</td><td>149</td><td>149</td></tr> <tr><td>30</td><td>30</td><td>70</td><td>70</td><td>110</td><td>110</td><td>150</td><td>150</td></tr> <tr><td>31</td><td>31</td><td>71</td><td>71</td><td>111</td><td>111</td><td>151</td><td>151</td></tr> <tr><td>32</td><td>32</td><td>72</td><td>72</td><td>112</td><td>112</td><td>152</td><td>152</td></tr> <tr><td>33</td><td>33</td><td>73</td><td>73</td><td>113</td><td>113</td><td>153</td><td>153</td></tr> <tr><td>34</td><td>34</td><td>74</td><td>74</td><td>114</td><td>114</td><td>154</td><td>154</td></tr> <tr><td>35</td><td>35</td><td>75</td><td>75</td><td>115</td><td>115</td><td>155</td><td>155</td></tr> <tr><td>36</td><td>36</td><td>76</td><td>76</td><td>116</td><td>116</td><td>156</td><td>156</td></tr> <tr><td>37</td><td>37</td><td>77</td><td>77</td><td>117</td><td>117</td><td>157</td><td>157</td></tr> <tr><td>38</td><td>38</td><td>78</td><td>78</td><td>118</td><td>118</td><td>158</td><td>158</td></tr> <tr><td>39</td><td>39</td><td>79</td><td>79</td><td>119</td><td>119</td><td>159</td><td>159</td></tr> <tr><td>40</td><td>40</td><td>80</td><td>80</td><td>120</td><td>120</td><td>160</td><td>160</td></tr> </tbody> </table>		A	B	A	B	A	B	A	B	1	1	41	41	81	81	121	121	2	2	42	42	82	82	122	122	3	3	43	43	83	83	123	123	4	4	44	44	84	84	124	124	5	5	45	45	85	85	125	125	6	6	46	46	86	86	126	126	7	7	47	47	87	87	127	127	8	8	48	48	88	88	128	128	9	9	49	49	89	89	129	129	10	10	50	50	90	90	130	130	11	11	51	51	91	91	131	131	12	12	52	52	92	92	132	132	13	13	53	53	93	93	133	133	14	14	54	54	94	94	134	134	15	15	55	55	95	95	135	135	16	16	56	56	96	96	136	136	17	17	57	57	97	97	137	137	18	18	58	58	98	98	138	138	19	19	59	59	99	99	139	139	20	20	60	60	100	100	140	140	21	21	61	61	101	101	141	141	22	22	62	62	102	102	142	142	23	23	63	63	103	103	143	143	24	24	64	64	104	104	144	144	25	25	65	65	105	105	145	145	26	26	66	66	106	106	146	146	27	27	67	67	107	107	147	147	28	28	68	68	108	108	148	148	29	29	69	69	109	109	149	149	30	30	70	70	110	110	150	150	31	31	71	71	111	111	151	151	32	32	72	72	112	112	152	152	33	33	73	73	113	113	153	153	34	34	74	74	114	114	154	154	35	35	75	75	115	115	155	155	36	36	76	76	116	116	156	156	37	37	77	77	117	117	157	157	38	38	78	78	118	118	158	158	39	39	79	79	119	119	159	159	40	40	80	80	120	120	160	160
Class. no.	Players					No.	Player in	Fouls																																																																																																																																																																																																																																																																																																																																																																																																																																																													
		1	2	3	4			5																																																																																																																																																																																																																																																																																																																																																																																																																																																													
		4																																																																																																																																																																																																																																																																																																																																																																																																																																																																			
		5																																																																																																																																																																																																																																																																																																																																																																																																																																																																			
		6																																																																																																																																																																																																																																																																																																																																																																																																																																																																			
		7																																																																																																																																																																																																																																																																																																																																																																																																																																																																			
		8																																																																																																																																																																																																																																																																																																																																																																																																																																																																			
		9																																																																																																																																																																																																																																																																																																																																																																																																																																																																			
		10																																																																																																																																																																																																																																																																																																																																																																																																																																																																			
		11																																																																																																																																																																																																																																																																																																																																																																																																																																																																			
		12																																																																																																																																																																																																																																																																																																																																																																																																																																																																			
		13																																																																																																																																																																																																																																																																																																																																																																																																																																																																			
		14																																																																																																																																																																																																																																																																																																																																																																																																																																																																			
		15																																																																																																																																																																																																																																																																																																																																																																																																																																																																			
A	B	A	B	A	B	A	B																																																																																																																																																																																																																																																																																																																																																																																																																																																														
1	1	41	41	81	81	121	121																																																																																																																																																																																																																																																																																																																																																																																																																																																														
2	2	42	42	82	82	122	122																																																																																																																																																																																																																																																																																																																																																																																																																																																														
3	3	43	43	83	83	123	123																																																																																																																																																																																																																																																																																																																																																																																																																																																														
4	4	44	44	84	84	124	124																																																																																																																																																																																																																																																																																																																																																																																																																																																														
5	5	45	45	85	85	125	125																																																																																																																																																																																																																																																																																																																																																																																																																																																														
6	6	46	46	86	86	126	126																																																																																																																																																																																																																																																																																																																																																																																																																																																														
7	7	47	47	87	87	127	127																																																																																																																																																																																																																																																																																																																																																																																																																																																														
8	8	48	48	88	88	128	128																																																																																																																																																																																																																																																																																																																																																																																																																																																														
9	9	49	49	89	89	129	129																																																																																																																																																																																																																																																																																																																																																																																																																																																														
10	10	50	50	90	90	130	130																																																																																																																																																																																																																																																																																																																																																																																																																																																														
11	11	51	51	91	91	131	131																																																																																																																																																																																																																																																																																																																																																																																																																																																														
12	12	52	52	92	92	132	132																																																																																																																																																																																																																																																																																																																																																																																																																																																														
13	13	53	53	93	93	133	133																																																																																																																																																																																																																																																																																																																																																																																																																																																														
14	14	54	54	94	94	134	134																																																																																																																																																																																																																																																																																																																																																																																																																																																														
15	15	55	55	95	95	135	135																																																																																																																																																																																																																																																																																																																																																																																																																																																														
16	16	56	56	96	96	136	136																																																																																																																																																																																																																																																																																																																																																																																																																																																														
17	17	57	57	97	97	137	137																																																																																																																																																																																																																																																																																																																																																																																																																																																														
18	18	58	58	98	98	138	138																																																																																																																																																																																																																																																																																																																																																																																																																																																														
19	19	59	59	99	99	139	139																																																																																																																																																																																																																																																																																																																																																																																																																																																														
20	20	60	60	100	100	140	140																																																																																																																																																																																																																																																																																																																																																																																																																																																														
21	21	61	61	101	101	141	141																																																																																																																																																																																																																																																																																																																																																																																																																																																														
22	22	62	62	102	102	142	142																																																																																																																																																																																																																																																																																																																																																																																																																																																														
23	23	63	63	103	103	143	143																																																																																																																																																																																																																																																																																																																																																																																																																																																														
24	24	64	64	104	104	144	144																																																																																																																																																																																																																																																																																																																																																																																																																																																														
25	25	65	65	105	105	145	145																																																																																																																																																																																																																																																																																																																																																																																																																																																														
26	26	66	66	106	106	146	146																																																																																																																																																																																																																																																																																																																																																																																																																																																														
27	27	67	67	107	107	147	147																																																																																																																																																																																																																																																																																																																																																																																																																																																														
28	28	68	68	108	108	148	148																																																																																																																																																																																																																																																																																																																																																																																																																																																														
29	29	69	69	109	109	149	149																																																																																																																																																																																																																																																																																																																																																																																																																																																														
30	30	70	70	110	110	150	150																																																																																																																																																																																																																																																																																																																																																																																																																																																														
31	31	71	71	111	111	151	151																																																																																																																																																																																																																																																																																																																																																																																																																																																														
32	32	72	72	112	112	152	152																																																																																																																																																																																																																																																																																																																																																																																																																																																														
33	33	73	73	113	113	153	153																																																																																																																																																																																																																																																																																																																																																																																																																																																														
34	34	74	74	114	114	154	154																																																																																																																																																																																																																																																																																																																																																																																																																																																														
35	35	75	75	115	115	155	155																																																																																																																																																																																																																																																																																																																																																																																																																																																														
36	36	76	76	116	116	156	156																																																																																																																																																																																																																																																																																																																																																																																																																																																														
37	37	77	77	117	117	157	157																																																																																																																																																																																																																																																																																																																																																																																																																																																														
38	38	78	78	118	118	158	158																																																																																																																																																																																																																																																																																																																																																																																																																																																														
39	39	79	79	119	119	159	159																																																																																																																																																																																																																																																																																																																																																																																																																																																														
40	40	80	80	120	120	160	160																																																																																																																																																																																																																																																																																																																																																																																																																																																														
Scores: Period 1 A _____ B _____ 2 A _____ B _____ Period 3 A _____ B _____ 4 A _____ B _____ Extra periods A _____ B _____		Final score: Team A _____ Team B _____ Name of winning team: _____																																																																																																																																																																																																																																																																																																																																																																																																																																																																			
Scorekeeper: _____ Timekeeper: _____ 24" Operator: _____		Referee: _____ Umpire 1: _____ Umpire 2: _____ Captain's signature in case of protest: _____																																																																																																																																																																																																																																																																																																																																																																																																																																																																			

Diagram 9 Scoresheet

- B.1 The scoresheet shown in Diagram 9 is the one approved by the IWBF Technical Commission.
- B.2 It consists of one original and three copies, each of a different colour of paper. The original, on white paper, is for IWBF. The first copy, on blue paper, is for the organising body of the competition, the second copy, on pink paper, is for the winning team, and the last copy, on yellow paper, is for the losing team.
- Note: 1. It is recommended that the scorer uses two different colours of pen, one for the first and third periods and one for the second and fourth periods.
2. The scoresheet may be prepared and completed electronically.
- B.3 At least twenty (20) minutes before the beginning of the game, the scorer shall prepare the scoresheet in the following manner:**
- B.3.1 He shall enter the names of the two teams in the space at the top of the scoresheet. The first team shall always be the local (home) team.
- For tournaments or games on a neutral playing court, the first team shall be the one mentioned first in the programme.
- The first team shall be **team 'A'** and the second team shall be **team 'B'**.
- B.3.2 He shall then enter:
- The name of the competition.
  - The number of the game.
  - The date, the time and the place of the game.
  - The names of the referee and the umpire(s).
  -

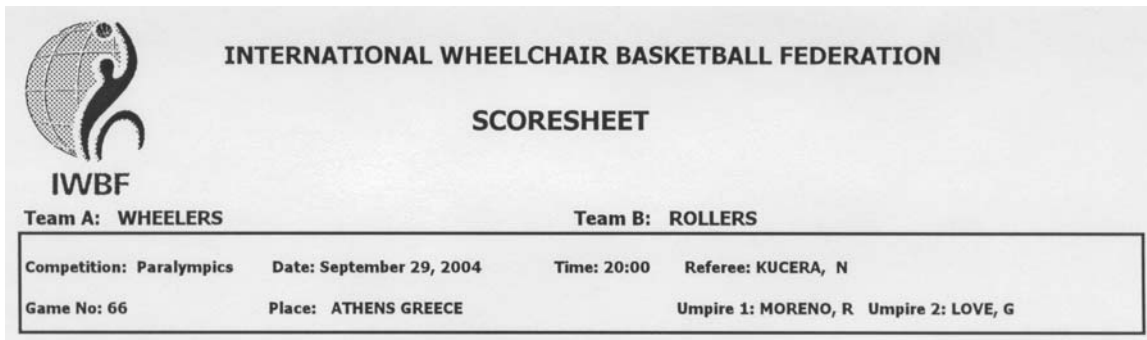

 INTERNATIONAL WHEELCHAIR BASKETBALL FEDERATION SCORESHEET			
Team A: WHEELERS	Team B: ROLLERS		
Competition: Paralympics	Date: September 29, 2004	Time: 20:00	Referee: KUCERA, N
Game No: 66	Place: ATHENS GREECE	Umpire 1: MORENO, R	Umpire 2: LOVE, G

**Diagram 10 Top of the scoresheet**

- B.3.3 He shall then enter the names of the members of each team, using the list of team members as provided by the coach or his representative. Team 'A' shall occupy the upper part of the scoresheet, and team 'B' the lower part.
- B.3.3.1 In the first column, the scorer shall enter the classification point(s) of each player as shown on their Player Classification ID Card.
- B.3.3.2 In the second column, the scorer shall enter each player's name and initials, all in BLOCK CAPITAL letters, beside the number corresponding to that which the player will be wearing during the game. The captain of the team shall be indicated by entering (CAP) immediately after his name.
- B.3.3.3 If a team presents fewer than twelve (12) players, the scorer shall draw a line through the spaces for the licence number, name, number, etc. of the player(s) who is not participating.
- B.3.4 At the bottom of each team's section, the scorer shall enter (in BLOCK CAPITAL letters) the names of the team's coach and assistant coach.



- B.4 At least ten (10) minutes before the game** the both coaches shall:
- B.4.1 Confirm their agreement with the names, the classification and the corresponding numbers of their team members.
  - B.4.2 Confirm the names of the coach and assistant coach.
  - B.4.3 Indicate the five (5) players who are to start the game by marking a small 'x' beside the player's number in the 'Player in' column.
  - B.4.4 Sign the scoresheet.  
The coach of team 'A' shall be the first to provide the above information.
- B.5 At the beginning of the game**, the scorer shall circle the small 'x' of the five (5) players in each team who are to start the game.
- B.6 During the game**, the scorer shall draw a small 'x' (not circled) in the 'Player in' column, beside the number of a player when he enters the game for the first time as a substitute.

Team B: WHEELERS									
Time-outs									
I	1	2	3	4	5	6	7	8	9
II	1	2	3	4	5	6	7	8	9
Period 1					Period 2				
Period 3					Period 4				
Extra periods									
Classif. no.	Players	No.	Player in	Fouls					
				1	2	3	4	5	
2.0	RAIMONDI, F	4	X	P <sub>2</sub>					
1.0	ABBOTT, M	5	X	P	P	P <sub>2</sub>			
2.0	HENDERSON, R	6	X	P <sub>2</sub>	U <sub>2</sub>	P	P <sub>1</sub>		
4.5	WARKENTIN, J	7	X	T <sub>2</sub>	P <sub>2</sub>				
4.0	MUNN, S	8	X	P	P	U			
3.5	BENOIT, C	9	X	P <sub>1</sub>	P				
4.0	van DER LINDEN, G	10							
1.0	BORISOFF, J	11	X	P <sub>3</sub>	P <sub>2</sub>				
4.5	ANDERSON, P	12	X	P <sub>2</sub>	P	P <sub>2</sub>	T <sub>C</sub>		
		13							
2.5	BAYE, P	14	X	P <sub>2</sub>	P <sub>2</sub>	P <sub>2</sub>	P <sub>1</sub>	U <sub>2</sub>	
4.5	NESS, B	15	X	P <sub>2</sub>	D <sub>2</sub>				
Coach: LOOR, A						C <sub>2</sub>	B <sub>2</sub>		
Assistant coach: MONTA, B									

Diagram 11 Teams on the scoresheet

- B.7 Time-outs**
- B.7.1 Time-outs granted shall be recorded on the scoresheet by entering the minute of the playing time of the period or extra period in the appropriate boxes below the team's name.
  - B.7.2 At the end of each half and extra period, unused boxes shall be marked with two horizontal parallel lines as appropriate.

## B.8 Fouls

- B.8.1 Player fouls may be personal, technical, unsportsmanlike or disqualifying and shall be recorded against the player.
- B.8.2 Coach, assistant coach, substitute and team follower fouls may be technical or disqualifying and shall be recorded against the coach.
- B.8.3 All fouls shall be recorded as follows:
- B.8.3.1 A personal foul shall be indicated by entering a 'P'.
- B.8.3.2 A technical foul against a player shall be indicated by entering a 'T'.
- B.8.3.3 A technical foul against the coach for his personal unsportsmanlike behaviour shall be indicated by entering a 'C'. A second similar technical foul shall also be indicated by entering a 'C', followed by a 'D' in the remaining space.
- B.8.3.4 A technical foul against the coach for any other reason shall be indicated by entering a 'B'.
- B.8.3.5 An unsportsmanlike foul shall be indicated by entering a 'U'. A second unsportsmanlike foul shall also be indicated by entering a 'U', followed by a 'D' in the remaining spaces.
- B.8.3.6 A disqualifying foul shall be indicated by entering a 'D'.
- B.8.3.7 Any foul involving a free throw(s) shall be indicated by adding the corresponding number of free throws (1, 2 or 3) beside the 'P', 'T', 'C', 'B', 'U' or 'D'.
- B.8.3.8 All fouls against both teams involving penalties of the same severity and cancelled according to Art. 42 (Special situations) shall be indicated by entering a small 'c' beside the 'P', 'T', 'C', 'B', 'U' or 'D'.
- B.8.3.9 At the end of each period, the scorer shall draw a thick line between the spaces that have been used and those that have not been used.  
At the end of the playing time, the scorer shall obliterate the remaining spaces with a thick horizontal line.

### B.8.3.10 Examples for disqualifying fouls:

Disqualifying fouls against coaches, assistant coaches, substitutes and team followers for leaving the team bench area (Art. 39) shall be recorded as shown below. In all remaining foul spaces of the disqualified person an 'F' shall be entered.

If only the coach is disqualified:

Coach	LOOR, A.	D <sub>2</sub>	F	F
Assistant Coach	MONTA, B.			

If only the assistant coach is disqualified:

Coach	LOOR, A.	B <sub>2</sub>		
Assistant Coach	MONTA, B.	F	F	F

If both the coach and the assistant coach are disqualified:

Coach	LOOR, A.	D <sub>2</sub>	F	F
Assistant Coach	MONTA, B.	F	F	F



If the substitute has fewer than four fouls, then an 'F' shall be entered in all remaining foul spaces:

4.0	TESCH, L.	9	⊗	P	P	F	F	F
-----	-----------	---	---	---	---	---	---	---

If it is the substitute's fifth foul, then an 'F' shall be entered inside the last foul space:

2.0	WILD, A	8	⊗	T	P	P	P	F
-----	---------	---	---	---	---	---	---	---

If the excluded player has already committed five fouls (fouled out), then an 'F' shall be entered in the column after the last foul:

4.5	JOHNSON, J	8	X	T	P	P	P	P	F
-----	------------	---	---	---	---	---	---	---	---

In addition to the above examples of the players Tesch, Wild and Johnson, or if a team follower is disqualified, a technical foul shall be entered:

Coach	LOOR, A.	B <sub>2</sub>		
Assistant Coach	MONTA, B.			

**Note:** Technical or disqualifying fouls according to Art. 39 shall not count as team fouls.

B.8.3.11 A disqualifying foul against a substitute (not including Art. 39) shall be recorded as follows:

1.5	KIRSTE, H.	7	⊗	D				0
-----	------------	---	---	---	--	--	--	---

And

Coach	LOOR, A.	B <sub>2</sub>		
Assistant Coach	MONTA, B.			

B.8.3.12 A disqualifying foul against an assistant coach (not including Art. 39) shall be recorded as follows:

Coach	LOOR, A.	B <sub>2</sub>		
Assistant Coach	MONTA, B.	D		

B.8.3.13 A disqualifying foul against an excluded player after his fifth foul (not including Art. 39) shall be recorded as follows:

4.0	OSHIMA, T	14	X	T	P	P	P	P	D
-----	-----------	----	---	---	---	---	---	---	---

And

Coach	LOOR, A.	B <sub>2</sub>		
Assistant Coach	MONTA, B.			

## B.9 Team fouls

B.9.1 For each period, four spaces are provided in the scoresheet (immediately below the team's name and above the players' names) in which to enter the team fouls.

B.9.2 Whenever a player commits a personal, technical, unsportsmanlike or disqualifying foul, the scorer shall record the foul against the team of that player by marking a large 'X' in the designated spaces in turn.

### B.10 The running score

- B.10.1 The scorer shall keep a chronological running summary of the points scored by each team.
- B.10.2 There are four columns on the scoresheet for this running score.
- B.10.3 Each column is divided again into four columns. The two on the left are for team 'A' and the two on the right for team 'B'. The centre columns are for the running score (160 points) for each team.

The scorer shall:

- **First**, draw a diagonal line (/) for any valid field goal scored and a filled circle (●) for any valid free throw scored, over the **new total** number of points as accumulated by the team that has just scored.
- **Then**, in the blank space on the same side of the new total number of points (beside the new / or ●), enter the number of the player who scored the field goal or the free throw.

### B.11 The running score: Additional instructions

- B.11.1 A three-point field goal scored by a player shall be recorded by drawing a circle around the player's number.
- B.11.2 A field goal accidentally scored by a player in his team's own basket shall be recorded as having been scored by the captain of the opposing team on the playing court.
- B.11.3 Points scored when the ball does not enter the basket) shall be recorded as having been scored by the player who attempted the shot.
- B.11.4 At the end of each period, the scorer shall draw a thick circle (⦿) around the latest number of points scored by each team and a thick horizontal line under those points and under the number of each player who scored those last points.
- B.11.5 At the beginning of each period the scorer shall continue to keep a chronological running summary of the points scored from the point of interruption.
- B.11.6 Whenever possible, the scorer should check his running score with the visual scoreboard. If there is a discrepancy, and his score is correct, he shall immediately take steps to have the scoreboard corrected. If in doubt or if one of the teams raises an objection to the correction, he shall inform the referee as soon as the ball is dead and the game clock is stopped.

A		B	
	1	●	6
	2	●	6
⑥	<del>3</del>	3	
	4	4	
11	<del>5</del>	5	⑤
11	●	●	5
	7	7	
10	<del>8</del>	8	
	9	9	⑩
	10	10	
⑩	<del>11</del>	11	
	12	12	⑦
4	<del>13</del>	13	7
5	●	14	
5	⑤	<del>15</del>	6
	16	16	
5	<del>17</del>	17	
	18	⑬	⑥
6	<del>19</del>	19	
	20	20	9
	21	21	
⑪	<del>22</del>	22	9
	23	●	9
11	<del>24</del>	24	
	25	25	7
	26	26	7
⑤	<del>27</del>	27	
	28	⑳	6
10	<del>29</del>	29	
	30	20	8
4	<del>31</del>	31	
	32	22	5
4	<del>33</del>	●	5
4	⦿	34	
	35	26	10
10	<del>36</del>	36	
	37	37	12
	38	38	
⑩	<del>39</del>	39	12
10	●	●	12

Diagram 12  
Running score



**B.12 The running score: Summing up**

- B.12.1 At the end of the game, the scorer shall draw two thick horizontal lines under the final number of points scored by each team and the numbers of the players who scored those last points. He shall also draw a diagonal line to the bottom of the column in order to obliterate the remaining numbers (running score) for each team.
- B.12.2 At the end of each period, the scorer shall enter the score of that period in the proper section in the lower part of the scoresheet.
- B.12.3 At the end of the game, the scorer shall enter the final score and the name of the winning team.
- B.12.4 The scorer shall then enter his surname, in block capital letters, on the scoresheet, after this has been done by the assistant scorer, timer and the twenty-four second operator.
- B.12.5 Once signed by the umpire(s), the referee shall be the last to approve and sign the scoresheet. This act terminates the officials' administration and connection with the game.

7	70	70	6
7	71	71	
7	72	<del>72</del>	6
	73	73	
9	74	74	
	75	75	
11	<del>76</del>	76	
	77	77	
	78	78	
	79	79	
	80	80	

**Diagram 13  
Summing up**

**Note:** Should one of the captains sign the scoresheet under protest (using the space marked 'Captain's signature in case of protest'), the table officials and the umpire(s) shall remain at the disposal of the referee until he gives them permission to leave.

<p><b>Scores:</b> Period 1 A <u>15</u> B <u>18</u> 2 A <u>19</u> B <u>10</u></p> <p>Period 3 A <u>26</u> B <u>19</u> 4 A <u>16</u> B <u>25</u></p> <p>Extra periods A <u>/</u> B <u>/</u></p>	<p><b>Final score:</b> Team A <u>76</u> Team B <u>72</u></p> <p>Name of winning team: <u>HOOPERS</u></p>
<p>Scorekeeper: <u>R. COPPENRATH</u></p> <p>Timekeeper: <u>T. ALLOUCHE</u></p> <p>24" Operator: <u>S. DURAND</u></p>	<p>Referee: <u>[Signature]</u></p> <p>Umpire 1: <u>[Signature]</u> Umpire 2: <u>[Signature]</u></p> <p>Captain's signature in case of protest: _____</p>

**Diagram 14 Bottom of the scoresheet**



---

## C - PROTEST PROCEDURE

---

If, during an IWBF official competition, a team believes its interests have been adversely affected by a decision of an official [referee or umpire(s)] or by any event that took place during a game, it must proceed in the following manner:

- C.1 The captain of that team shall, immediately at the end of the game, inform the referee that his team is protesting against the result of the game and sign the scoresheet in the space marked 'Captain's signature in case of protest'.

To make this protest valid, it is necessary for the official representative of the national federation or of the club to give confirmation of this protest in writing. This must be made within twenty (20) minutes following the end of the game.

Detailed explanations are not necessary. It is sufficient to write: 'The national federation (or club) X protests against the result of the game between the teams X and Y'. Then he shall deposit with the IWBF representative or with the President of the Tournament Technical Committee, a sum equivalent to US\$ 500 as security.

The national federation of the team or the club in question must submit to the IWBF representative or to the President of the Tournament Technical Committee the text of its protest within the hour following the end of the game.

If the protest is accepted, the security will be refunded.

- C.2 The commissioner or the referee shall, within the hour following the end of the game, report the incident which lead to the protest, to the IWBF representative or to the President of the Tournament Technical Committee.

- C.3 Should the national federation of the team or the club in question, or that of the opposing team or club, not be in agreement with the decision of the Tournament Technical Committee, it may then address an appeal to the Jury of Appeal.

To make this appeal valid, it must be made, in writing, within twenty (20) minutes following the delivery of the decision of the Tournament Technical Committee and be accompanied by a deposit equivalent to US\$ 1000, as security.

The Jury of Appeal shall judge the appeal in the last instance, and its decision shall be final.

- C.4 Videos, film, pictures or any equipment, visual, electronic, digital, or otherwise, may be used only to:
- Decide if a last shot at the end of each period or any extra period was released during playing time.
  - Determine responsibility in matters of discipline or for educational (training) purposed after the game has ended.



## D - CLASSIFICATION OF TEAMS

### D.1 Procedure

Teams shall be classified according to their win-loss records, namely two (2) points for each game won, one (1) point for each game lost (including lost by default) and zero (0) points for a game lost by forfeit.

- D.1.1 If there are two teams in the classification with equal points, the result(s) of the game(s) between the two teams involved will be used to determine the placings.
- D.1.2 If the points and the goal average in the games between the two teams are still the same, the classification will be determined by the goal average of all the games played in the group by each team.
- D.1.3 If more than two teams are equal in the placing, a second classification will be established, taking into account only the results of the games between the teams that are tied.
- D.1.4 If there are still teams tied after the second classification, then goal average will be used to determine the placing, taking into account only the results of the games between the teams still tied.
- D.1.5 If there are still teams tied, the placing will be determined using the goal average from the results of all their games played in the group.
- D.1.6 If, at any stage, using the above criteria, a multiple team tie is reduced to a tie involving only two teams, the procedure in D.1.1 and D.1.2 above will be applied.
- D.1.7 If, at any stage, it is reduced to a tie still involving more than two teams, the procedure, beginning with D.1.3 above, is repeated.
- D.1.8 Goal average will always be calculated by division.

### D.2 Exception:

If only three teams take part in a competition and the situation cannot be resolved following the steps outlined above (the goal average by division is identical), then the points scored will determine the placing.

#### Example:

Results between A, B, C:

A vs. B	82 - 75
A vs. C	64 - 71
B vs. C	91 - 84

Team	Games played	Wins	Losses	Points	Goal difference	Goal average
A	2	1	1	3	146 : 146	1.000
B	2	1	1	3	166 : 166	1.000
C	2	1	1	3	155 : 155	1.000

Therefore:

1 <sup>st</sup>	B - 166 points scored
2 <sup>nd</sup>	C - 155 points scored
3 <sup>rd</sup>	A - 146 points scored

If the teams are still tied after all the above steps have been followed, a draw will be used for the final placing. The method for the draw will be determined by the commissioner or by the competent local authority.

**D.3 Further examples of the classification rule:**

D.3.1 Two teams - equal points and only one game played between them.

Team	Games played	Wins	Losses	Points
A	5	4	1	9
B	5	4	1	9
C	5	3	2	8
D	5	2	3	7
E	5	2	3	7
F	5	0	5	5

The winner of the game between A and B will be classified first and the winner of D and E will be classified fourth.

D.3.2 Two teams - equal points and two games played between them.

Team	Games played	Wins	Losses	Points
A	10	7	3	17
B	10	7	3	17
C	10	6	4	16
D	10	5	5	15
E	10	3	7	13
F	10	2	8	12

Results between A, B:

D.3.2.1 A won both games:

Therefore

1 <sup>st</sup>	A
2 <sup>nd</sup>	B

D.3.2.2 Each team won one game:

A vs. B	90 - 82
B vs. A	69 - 62

Goal difference:	A	152 - 151
	B	151 - 152

Goal average:	A	1.0066
	B	0.9934

Therefore

1 <sup>st</sup>	A
2 <sup>nd</sup>	B

D.3.2.3 Each team won one game:

A vs. B	90 - 82
B vs. A	70 - 62

The two teams have the same goal difference (152 - 152) and the same goal average by division (1.000).

The placing will be determined using the goal average from the results of all their games played in the group.



D.3.3 More than two teams - equal points:

Team	Games played	Wins	Losses	Points
A	5	4	1	9
B	5	4	1	9
C	5	4	1	9
D	5	2	3	7
E	5	1	4	6
F	5	0	5	5

Results between A, B, C: A vs. B 82 - 75  
A vs. C 77 - 80  
B vs. C 88 - 77

Team	Games played	Wins	Losses	Points	Goal difference	Goal average
A	2	1	1	3	159 - 155	1.0258
B	2	1	1	3	163 - 159	1.0251
C	2	1	1	3	157 - 165	0.9515

Therefore  
1<sup>st</sup> A  
2<sup>nd</sup> B  
3<sup>rd</sup> C

If the goal average is the same for the three teams, the final placing will be determined from the results of all their games played in the group.

D.3.4 More than two teams - equal points:

Team	Games played	Wins	Losses	Points
A	5	3	2	8
B	5	3	2	8
C	5	3	2	8
D	5	3	2	8
E	5	2	3	7
F	5	1	4	6

The second classification will be established, taking into account only the results of the games between the teams that are tied.

There are two possibilities:

Team	I.		II.	
	Wins	Losses	Wins	Losses
A	3	0	2	1
B	1	2	2	1
C	1	2	1	2
D	1	2	1	2





---

## E - TELEVISION (TV) TIME-OUTS

---

### E.1 Definition

The organising body of a competition may decide for itself whether TV time-outs shall be applied and, if so, of what duration (60, 75, 90 or 100 seconds).

### E.2 Rule

E.2.1 One (1) TV time-out in each period is permissible, in addition to the regular time-outs. TV time-outs in extra periods are not permissible.

E.2.2 The first time-out of each period (team or TV) shall be 60, 75, 90 or 100 seconds in duration.

E.2.3 The duration of all other time-outs in a period shall be sixty (60) seconds.

E.2.4 Both teams shall be entitled to two (2) time-outs during the first half and three (3) time-outs during the second half.

These time-outs may be requested at any time during the game and their duration may be:

- 60, 75, 90 or 100 seconds, if considered to be a TV time-out, i.e. the first in a period, or
- Sixty (60) seconds, if not considered to be a TV time-out, i.e. requested by either team, after the TV time-out has been granted.

### E.3 Procedure

E.3.1 Ideally, the TV time-out should be taken with five (5) minutes remaining in the period. However, there is **no** guarantee that this will be the case.

E.3.2 If neither team has requested a time-out before the last five (5) minutes remaining in the period then a TV time-out shall be granted at the first opportunity when the ball is dead and the game clock is stopped. This time-out will not be charged against either team.

E.3.3 If either team is granted a time-out before the last five (5) minutes remaining in the period, that time-out shall be used as a TV time-out.

This time-out shall count as both a TV time-out and a time-out for the team requesting it.

E.3.4 According to this procedure, there would be a minimum of one (1) time-out in each period and a maximum of six (6) time-outs in the first half and a maximum of eight (8) time-outs in the second half.

**END OF RULES  
AND  
GAME PROCEDURES**



---

## INDEX TO THE RULES

---

Act of shooting	
definition .....	24
foul on player .....	44
Advantage/disadvantage concept.....	42
All-in-ones.....	15
Alternating possession .....	21
Anti-tip Castors .....	13
Assistant Coach	
duties and power .....	17
scoresheet .....	18
Assistant scorer	
duties .....	58
Backcourt	
ball returns to.....	36
definition .....	36
Ball	
control.....	23
dead .....	20
enters from below .....	25
enters own basket .....	25
kicking.....	23
live .....	20
progressing with the .....	33
returns to backcourt.....	36
status .....	20
striking with the fist .....	23
within basket.....	24
Ball lodges on basket support.....	22
Basket	
ball enters from below .....	25
ball enters own .....	25
ball within.....	24
change for second half .....	20
opponents.....	7
own .....	7
Basketball	
equipment.....	12
Beginning of a period.....	19
Beginning of game.....	19
Blocking .....	42
Boundary lines.....	8
Captain	
acting as coach.....	17
coach.....	17
duties and powers .....	17
Centre circle .....	10
Centre line .....	10



Charging .....	42
Charging by dribbler .....	42
Classification of teams.....	77
Closely guarded player.....	34
Coach	
disqualification.....	48
duties and power .....	18
member of team .....	15
standing.....	18
team list.....	18
technical foul.....	47
Colour of shirts .....	16
Commissioner	
definition .....	56
Commissioner's report.....	56
Contact.....	38
Continuous movement.....	24
Control of the ball .....	23
Correctable error .....	53
Court	
dimensions .....	8
lines.....	8
Cushions.....	13
Cylinder principle	
definition .....	39
Dead ball .....	20
Decision of game.....	7
Decisions	
time and place for .....	55
Definition of game.....	7
Disqualifying foul .....	45
Doctor.....	17
Double foul .....	44
Dribbling	
definition .....	32
Eight-second.....	34
Eligible to play .....	15
End of game	
definition .....	19
officials power.....	56
video.....	76
Ending of a period .....	19
Endlines.....	8
Entitled to play .....	15
Equipment .....	12
Excluded player	
definition .....	15
Extra period	
definition .....	19
ending.....	20
intervals .....	19



Fighting.....	49
Fingernails.....	16
Five fouls.....	15, 50
Five seconds	
closely guarded player.....	34
throw-in.....	25
Foul	
after playing time.....	19
at end of playing time.....	19
definition.....	38
disqualification of coach.....	45
disqualifying.....	45
during alternating possession.....	45
fighting.....	49
five by player.....	50
penalty.....	50
penalty situation.....	50
personal.....	44
player in the act of shooting.....	44
special situations.....	50
technical by coach.....	48
technical by player.....	48
unsportsmanlike.....	45
violence.....	47
Four fouls by team.....	50
Free throws.....	51
Free-throw line.....	10
Free-throw shooter	
determination.....	17
duties.....	51
substitution.....	28
Frontcourt	
ball goes into.....	34
definition.....	34
Fumble of the ball.....	33
Game	
beginning.....	19
decision.....	7
ending.....	19
lost by default.....	30
lost by forfeit.....	30
playing time.....	19
Game ball.....	56
Game clock	
operations.....	59
Goal	
from below.....	25
own basket, accidentally.....	23
own basket, deliberately.....	23
value.....	24
when made.....	24



Goal average .....	77
Guarding	
a player who controls the ball .....	40
a player who does not control the ball .....	41
Half-time interval.....	19
Hands	
contacting opponents .....	43
use of.....	43
Held ball.....	21
Holding .....	43
Home team.....	15
Illegal guarding from the rear.....	43
Injury	
player.....	17
Interpreter .....	15
Interval of play	
definition .....	19
duties of timer .....	59
Kicking the ball .....	23
Legal guarding position .....	39
Live ball .....	20
Lifting.....	36
Location of a player .....	21
Location of an official.....	21
Manager .....	15
Normal basketball position.....	39
Numbers	
on shirts.....	16
Objects	
worn by player .....	16
Official	
definition .....	56
disagreement.....	57
location .....	21
powers.....	56
signals	
administrative .....	63
clock related .....	63
free-throw administration .....	68
reporting a foul.....	65
scoring.....	63
violations.....	64
time and place for decisions .....	56
uniform.....	56
Opponents basket .....	7
Other equipment.....	16
Out-of-bounds	
ball.....	32
player.....	32
Own basket.....	7
Penalty for	
disqualifying foul .....	46



double foul .....	44
fighting .....	49
free-throw violations .....	53
game lost by default .....	31
game lost by forfeit .....	30
personal foul .....	44
technical foul by coach .....	48
technical foul by player .....	47
technical foul during interval of play.....	47
throw-in violation.....	26
unsportsmanlike foul.....	45
violations.....	32
Penalty situation .....	50
Period	
beginning .....	19
definition .....	19
ending.....	19
Personal contact.....	38
Personal foul.....	44
Physiotherapist.....	15
Player	
becomes substitute.....	15, 28
closely guarded .....	34
control of the ball .....	23
entitled to play .....	15
five fouls .....	15, 50
in act of shooting .....	23
injury.....	17
location .....	21
number .....	16
on the floor.....	32
starting five .....	18
substitution .....	28
technical foul.....	47
wearing objects.....	16
Player coach.....	18
Player control	
definition .....	23
Playing court	
dimensions .....	8
lines .....	8
Playing time .....	19
Principle of verticality.....	39
Protest	
procedure .....	76
referee's report .....	57
Pushing .....	43
Quarter .....	19
Raising the wheels .....	36
Rebound places.....	10, 52
Referee	



definition .....	56
powers .....	56
Restricted area .....	10
Rules of conduct	
definition .....	46
Scorer	
duties .....	58
Scorer's table.....	12
Scoresheet	
examination .....	56
form .....	69
procedure .....	70
Screening .....	42
Semicircle .....	10
Shirts	
colour.....	16
numbers.....	16
Shorts .....	16
Shot for goal	
definition .....	23
Sidelines .....	8
Special situations.....	50
Starting five players .....	18
Statistican .....	15
Striking the ball with the fist .....	23
Substitute	
becomes player .....	15, 28
Substitution	
free-throw shooter .....	28
Substitution space .....	12
Substitution opportunity .....	28
Table officials	
definition .....	56
uniform.....	56
Tap .....	22
Tap-off .....	21
Tap-off situation.....	22
Team bench area	
definition .....	10
Team control	
definition .....	23
Team follower .....	15
Team foul penalty situation.....	50
Team fouls.....	50
Team member	
definition .....	15
Teams .....	15
Television time-out .....	81
Traveling (Three Pushes) .....	33
Three-point field goal area.....	10
Three-second .....	33



Throw-in	
definition .....	25
five seconds.....	26
Tied score.....	19
Timer	
duties .....	59
Time-out	
definition .....	27
duties of scorer .....	58
duties of timer .....	59
opportunity.....	27
T-shirts .....	15
Twenty-four second device	
reset in error .....	35
sounds in error.....	35
Twenty-four second operator	
duties .....	60
Twenty-four second rule .....	35
Umpire	
definition .....	56
Undergarments.....	16
Uniform	
officials, referee and umpire .....	56
player.....	15
table officials.....	56
Unsportsmanlike behaviour	
referee's report .....	57
Unsportsmanlike foul .....	45
Verticality	
definition .....	39
legal guarding position.....	39
Video usage.....	76
Violation	
special situations .....	50
Violations	
definition .....	32
Violence.....	47
Visiting team.....	16
Wheelchair.....	13